

Dell™ PowerVault™ 124T LTO-2 Autoloader User's Guide

[Introduction](#)

[Installing the Autoloader](#)

[Operating the Autoloader](#)

[Remote Management Unit](#)

[Front Panel Administration](#)

[Diagnostics](#)

[Troubleshooting](#)

[Technical Specifications](#)

[Getting Help](#)

Notes, Notices, and Cautions



NOTE: A NOTE indicates important information that helps you make better use of your system.



NOTICE: A NOTICE indicates either potential damage to hardware or loss of data and tells you how to avoid the problem.



CAUTION: A CAUTION indicates a potential for property damage, personal injury, or death.

Information in this document is subject to change without notice.
© 2005-2007 Dell Inc. All rights reserved.

Reproduction in any manner whatsoever without the written permission of Dell Inc. is strictly forbidden.

Trademarks used in this text: *Dell*, the *DELL* logo, *PowerVault*, *Dimension*, *Inspiron*, *OptiPlex*, *Latitude*, *Dell Precision*, *PowerApp*, *PowerEdge*, *PowerConnect*, and *DellNet* are trademarks of Dell Inc.; *Microsoft*, *Windows*, *Windows NT*, and *Windows Server* are registered trademarks of Microsoft Corporation. *DLTape* is a registered trademark of Quantum Corporation. *Adobe* is either a registered trademark or trademark of Adobe Systems Incorporated in the United States and/or other countries. *RedHat* is a registered trademark of Red Hat, Inc. *Mozilla* and *Firefox* are trademarks of Mozilla.

Other trademarks and trade names may be used in this document to refer to either the entities claiming the marks and names or their products. Dell Inc. disclaims any proprietary interest in trademarks and trade names other than its own.

Initial release: 15 Jun 2005
Revised: September 2007

[Back to Contents Page](#)

Front Panel Administration: Dell™ PowerVault™ 124T LTO-2 Autoloader User's Guide

- [Configuring the Autoloader](#)
- [SCSI Barcode Length](#)
- [Setting the SCSI ID](#)
- [Setting Security](#)
- [Setting Ethernet](#)
- [Setting Magazines](#)
- [Setting the Time](#)
- [Setting Passwords](#)
- [Barcode Reader](#)

When you first power on the Dell PowerVault 124T LTO-2 autoloader, it automatically runs a Power-On Self-Test (POST). During the POST, the left (green) LED flashes. After the POST, the left (green) and right (amber) LED flash alternately back and forth. Do one of the following:

- 1 If the autoloader powers on successfully, continue configuring the autoloader (see "[Configuring the Autoloader](#)").

 **NOTE:** The front panel requires a six-digit password to change the configuration (see "[Setting Passwords](#)"). The LCD front panel default password for the Administrator is **000000**. The default password for the Operator is **111111**.

- 1 If the autoloader does not power on successfully, check the following:
 - o Power switch is on.
 - o Power cable is inserted correctly.
 - o SCSI bus is terminated.
 - o SCSI cable is connected to the autoloader and host computer.
 - o No error code appears on the autoloader LCD.

If you cannot resolve the problem yourself, contact your service representative or go to support.dell.com.

When you first power on the autoloader, the setting for the Internet Protocol (IP) address is static with the address **192.168.20.128**. If you want to use Dynamic Host Configuration Protocol (DHCP) to change the IP address, see "[Setting the IP Address](#)." To determine the IP address when using DHCP, view the Ethernet status information (see "[Setting the SCSI ID](#)").

Configuring the Autoloader

To configure the autoloader, start with the main menu on the front panel. If the main menu is not already visible on the LCD, press **Enter**.

When you first power on the autoloader, the default is set with no password protection. However, after you set the security option, all the configuration functionality is password-protected. You need an administrator-level password to configure the autoloader.

The front panel menu has the following options:

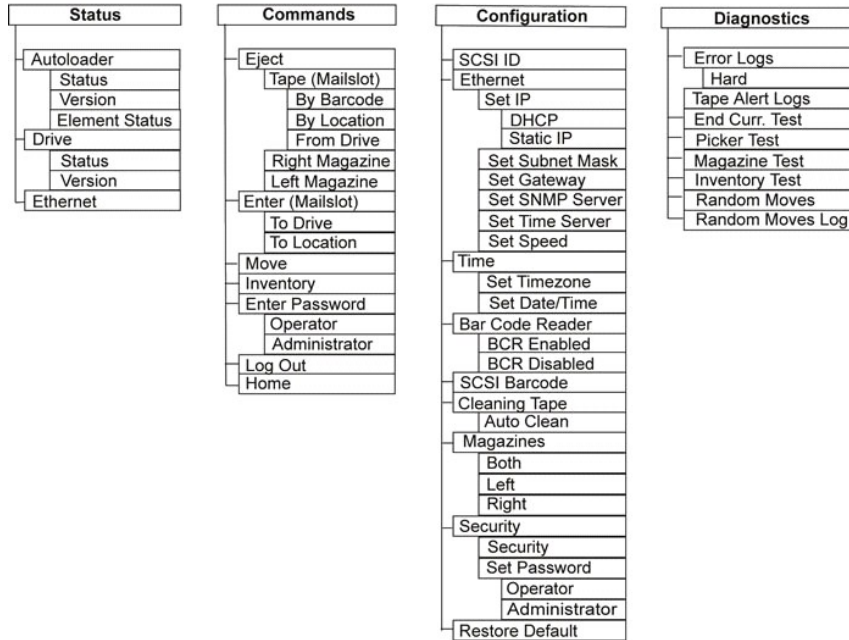

To configure the Dell PowerVault 124T LTO-2 autoloader, you must verify the setup of the following:

- 1 SCSI ID(s). For the autoloader, there is a single SCSI ID.
- 1 Magazine(s).
- 1 Ethernet IP address (if you are not using DHCP).
- 1 SNMP server IP address—only if SNMP is being used.
- 1 Time server IP address (or the time zone, date, and time, if configuring manually)—only if a time server is being used.
- 1 Control mode.
- 1 Security option.

Setting the SCSI ID

Each SCSI device attached to a server or workstation must have a unique SCSI ID. For the PowerVault 124T autoloader, you need one SCSI ID.

To set the SCSI ID:

1. If the main menu is not already visible, press **Enter**.
2. On the main menu, scroll to **Configuration** and press **Enter**.
3. On the **Configuration** submenu, scroll to **SCSI ID** and press **Enter**.
4. Scroll to the number you want to set as the autoloader's SCSI ID, then press **Enter**. *Cycle Power* new SCSI ID appears on the LCD.
5. Press and hold the power button on the front panel until *System Shutdown wait 60 sec* appears on the LCD. *Power Off* appears on the LCD, then the autoloader shuts off.
6. Press the power button again to power on the autoloader. The new SCSI ID is now in effect.

Setting Ethernet

Ethernet is the method used by the autoloader to access a network. With an Ethernet connection, you can remotely access the autoloader over the network. To use the Ethernet connection, you must define the following:

- 1 A dynamic or static IP address for the autoloader (required)
- 1 A subnet mask (required for static IP)

- 1 An IP gateway (optional)
- 1 A Simple Network Management Protocol (SNMP) server (optional)
- 1 A time server, or set the time and time zone manually (optional)

Setting the IP Address

An IP address is the address of any device attached to a network. Each device must have a unique IP address. IP addresses are written as four sets of numbers separated by periods ranging from 0.0.0.0 up to and including 255.255.255.255.

IP addresses are either permanent or dynamically assigned. A permanent, or static, address remains the same each time the device connects to the network. A dynamic address may change each time the device connects to the network server using Dynamic Host Configuration Protocol (DHCP).

To set a dynamic IP address:

1. From the main menu, scroll to **Configuration**, and then press **Enter**.
2. From the **Configuration** menu, scroll to **Ethernet**, and then press **Enter**.
3. From the **Ethernet** submenu, scroll to **Set IP**, and then press **Enter**.
4. Scroll to **DHCP**, and then press **Enter**.

To set a static IP address:

1. From the main menu, scroll to **Configuration**, and then press **Enter**.
2. From the **Configuration** menu, scroll to **Ethernet**, and then press **Enter**.
3. From the **Ethernet** submenu, scroll to **Set IP**, and then press **Enter**.
4. Scroll to **Static IP**, and then press **Enter**. The cursor automatically appears at the first digit.
5. At each position of the IP address, use the up and down arrows to change the value of each digit. Press **Enter** to advance the cursor to the next digit.

When you have advanced through all of the digits of the IP address, the autoloader displays **Enter** to save.

 **NOTE:** If you make a mistake, press **Escape** to backspace to the digit you want to change.

6. Press **Enter**. The **Configuration** submenu appears and the static IP is now in effect. You do not need to reboot the autoloader.
7. Press **Escape** or **Enter** to return to the Ethernet submenu.

Setting the Subnet Mask

Creating a subnet mask is a method of splitting IP networks into a series of subgroups, or subnets, to improve performance or security.

To set a subnet mask:

1. From the main menu, scroll to **Configuration**, and then press **Enter**.
2. From the **Configuration** menu, scroll to **Ethernet**, and then press **Enter**.
3. From the **Ethernet** submenu, scroll to **Set Subnet Mask**, and then press **Enter**.
4. At each position of the Subnet Mask address, use the up and down arrows to change the value of each digit. Press **Enter** to advance the cursor to the next digit.

When you have advanced through all of the digits of the subnet mask address, the autoloader displays **Enter** to save.

 **NOTE:** If you make a mistake, press **Escape** to backspace to the digit you want to change.

5. Press **Enter**. New Subnet Mask xxx.xxxx.xxx.xxx appears on the LCD. You do not need to reboot the autoloader.
6. Press **Escape** or **Enter** to return to the Ethernet submenu.

Setting an IP Gateway

1. From the main menu, scroll to **Configuration**, and then press **Enter**.
2. From the **Configuration** menu, scroll to **Ethernet**, and then press **Enter**.
3. From the **Ethernet** submenu, scroll to **Set Gateway**, and then press **Enter**. The cursor automatically appears at the first digit.
4. At each position of the gateway address, use the up and down arrows to change the value of each digit. Press **Enter** to advance the cursor to the next digit.

When you have advanced through all of the digits of the gateway address, the autoloader displays **Enter** to save.

 **NOTE:** If you make a mistake, press **Escape** to backspace to the digit you want to change.

5. Press **Enter**. New Gateway is xxx.xxx.xxx.xxx appears on the LCD. You do not need to reboot the autoloader.
6. Press **Escape** or **Enter** to return to the Ethernet submenu.

Setting the SNMP Server

An SNMP server monitors a network by processing reporting activity in each network device (hub, router, bridge, and so on). The server uses this information to define what is obtainable from each device and what can be controlled (turned off, on, and so on).

 **NOTE:** The PV124T SNMP agent supports only the MIB-II variable group. The MIB provides power-on notification commonly referred to as the "cold start trap" which is sent to the SNMP host (if configured). Embedded webserver user interface is supported for configuring the SNMP server. However, extended SNMP functions such as availability of tape information through SNMP, SNMP traps for tape events, availability of global tape status information through SNMP, availability of information through SNMP to classify the loader as a tape device, etc. are not supported.

To set an SNMP server:

1. From the main menu, scroll to **Configuration**, and then press **Enter**.
2. From the **Configuration** menu, scroll to **Ethernet**, and then press **Enter**.
3. From the **Ethernet** submenu, scroll to **Set SNMP Server**, and then press **Enter**. The cursor automatically appears at the first digit.
4. At each position of the SNMP server address, use the up and down arrows to change the value of each digit. Press **Enter** to advance the cursor to the next digit.

When you have advanced through all of the digits of the SNMP server address, the autoloader displays **Enter** to save.

 **NOTE:** If you make a mistake, press **Escape** to backspace to the digit you want to change.

5. Press **Enter**. New SNMP Server xxx.xxx.xxx.xxx appears on the LCD. You do not need to reboot the autoloader.
6. Press **Escape** or **Enter** to return to the Ethernet submenu.

Setting the Time

The system time is displayed by the Remote Management Unit and it is used internally when logging events and errors. The system time is either regular time or power-on time. Regular time is Month/Date/Year Time, such as Nov/21/2004 19:28. Power-on time is Power On Cycles (POC)/Power On Hours (POH). For example, POC: 00121, POH: 00002:07:45 where POC is the number of times the system has booted since it was manufactured, and POH is the number of hours, minutes, and seconds since the last system boot. If regular time is known, it will be used, otherwise power-on time is used.

The PowerVault 124T autoloader must be reset after each power up. The time can be reset automatically if a time server is configured (see "[Setting the Time Server](#)").

Setting the Time Server

If you locate a time server that is compatible with Simple Network Time Protocol (SNTP), you can connect the autoloader to a server that will supply the correct date and time. The autoloader uses this information to time stamp information in its memory.

To set a time server:

1. From the main menu, scroll to **Configuration**, and then press **Enter**.
2. From the **Configuration** menu, scroll to **Ethernet**, and then press **Enter**.
3. From the **Ethernet** submenu, scroll to **Set Time Server**, and then press **Enter**. The cursor automatically appears at the first digit.
4. At each position of the time server address, use the up and down arrows to change the value of each digit. Press **Enter** to advance the cursor to the next digit.

When you have advanced through all of the digits of the time server address, the autoloader displays **Enter** to save.

 **NOTE:** If you make a mistake, press **Escape** to backspace to the digit you want to change.

5. Press **Enter**. New Time Server xxx.xxx.xxx.xxx appears on the LCD. You do not need to reboot the autoloader.
6. Press **Escape** or **Enter** to return to the Ethernet submenu.

To set the time zone:

1. From the main menu, scroll to **Configuration**, and then press **Enter**.
2. From the **Configuration** menu, scroll to **Time**, and then press **Enter**.
3. From the **Time** submenu, scroll to **Set Timezone**, and then press **Enter**. The **Time Zone** screen appears, allowing you to set the hours. The cursor automatically appears at the first digit.

4. Scroll to set the number of hours difference between your local time and Greenwich Mean Time (GMT).
5. Scroll to set the number of minutes difference between your local time and GMT, then press **Enter**. The new time zone is set.
6. Press **Escape** or **Enter** as necessary to return to the main menu.

To set the date and time:

1. From the main menu, scroll to **Configuration**, and then press **Enter**.
 2. From the **Configuration** menu, scroll to **Time**, and then press **Enter**.
 3. From the **Time** submenu, scroll to **Set Date/Time**, and then press **Enter**. The **Date/Time** screen appears, allowing you to set the date and time. The cursor automatically appears at the first digit.
 4. The first four digits represent the current year. At each position of the year, use the up and down arrows to change the value of each digit. Press **Enter** to advance the cursor to the next digit.
 5. The next two digits represent the current month. At each position of the month, use the up and down arrows to change the value of each digit. Press **Enter** to advance the cursor to the next digit.
 6. The next two digits represent the current day. At each position of the day, use the up and down arrows to change the value of each digit. Press **Enter** to advance the cursor to the next digit.
 7. The next two digits represent the current hour. At each position of the hour, use the up and down arrows to change the value of each digit. Press **Enter**.
 8. The last two digits represent the current minute. At each position of the minute, use the up and down arrows to change the value of each digit. Press **Enter** to advance the cursor to the next digit.
 9. Press **Enter** to save.
 10. Press **Escape** as necessary to return to the main menu.
-

Barcode Reader

You can enable or disable the Barcode Reader from the Operator Control Panel (OCP). Disabling the barcode reader prevents the barcode reader from attempting to read label information. If barcode labels are not being used, disabling the barcode reader will reduce initialization time.

Either a power cycle (through the front panel button) or an Autoloader Reset (through the Autoloader Reset command found on the Error Logs and Diagnostics page of the Web interface) is required for the change to take effect.

To change the Barcode Reader setting:

1. From the main menu, scroll to **Configuration**, and then press **Enter**.
 2. From the **Configuration** menu, scroll to **Barcode Reader** and press **Enter**.
 3. A checkmark will be present before either **Barcode Enabled** or **Barcode Disabled** to indicate the current setting. Scroll to the desired setting and press **Enter**.
 4. Press **Esc** as necessary to return to the main menu.
 5. Power cycle the autoloader as requested.
-

SCSI Barcode Length

SCSI Barcode Length sets the maximum number of barcode characters that will be returned in the SCSI Read Element Data. The display of barcode information on the Web interface and Operator Control Panel (OCP) are unaffected by this setting.

Setting the SCSI Barcode Length to 0 disables truncation of the barcode and the full barcode will be returned in the SCSI Read Element Data.

This setting is particularly useful if you have a pool of media previously catalogued by another device that has a limitation on the number of barcode characters that can be read (typically 6 or 9). Adjusting the PV124T setting to match the previous hardware prevents the user from having to re-catalog all barcode labeled media previously used in the other device.

To change the SCSI Barcode setting:

1. From the main menu, scroll to **Configuration**, and then press **Enter**.
2. From the **Configuration** menu, scroll to **SCSI Barcode** and press **Enter**.
3. Scroll to the desired setting (from 0 to 15) and press **Enter**.
4. Press **Esc** as necessary to return to the main menu. The autoloader does not need to be reset when making this change.

Setting Magazines

In some cases, autoloader owners were being charged Independent Software Vendor (ISV) licensing fees for two-magazine autoloaders although only one magazine was configured. This occurred because the ISV software was registering the autoloader as a two-magazine device, regardless of the number of magazines configured. You have the ability to set the number of magazines in the autoloader. The default setting is **Left**.

To set the number of magazines:

1. From the main menu, scroll to **Configuration**, and then press **Enter**.
2. From the **Configuration** menu, scroll to **Magazines**, and then press **Enter**.
3. From the **Magazines** menu, select either **Right**, **Left**, or **Both** to indicate the magazines installed in the autoloader.

 **NOTE:** The default setting must be reconfigured if the optional right magazine is installed. Host backup software may also require a configuration change to support the additional media locations.

Setting Security

You can add security to the front panel by password-protecting the autoloader's functionality. The security setting only protects the front panel functionality. The default setting is **Off**, meaning that no password is required. However, you can enable the security option so that users must enter a password to access functionality.

Security Option

When you first power on the autoloader, the security option is set to **Off**. Use the following procedure to enable the security option. You must have an administrator-level password to set passwords.

To set the security option:

1. From the main menu, scroll to **Configuration**, and then press **Enter**.
 2. From the **Configuration** menu, scroll to **Security**. If a check mark appears before the word, the security option is **On**. If no check mark appears, the security option is **Off**.
 3. Press **Enter**. If you are not logged in as Administrator, press **Enter** again to log in.
 4. To change the option, press **Enter**. For example, if the security option was set to **On**, it is now set to **Off**, and no check mark appears.
-

Setting Passwords

Many operations on the autoloader are password-protected to ensure data integrity. You can set passwords to administrator level and to operator level. Operator-level users have access to the **Commands** and **Status** menus. Administrator-level users have access to all functionality.

To set a password:

1. From the main menu, scroll to **Configuration**, and then press **Enter**.
2. From the **Configuration** menu, scroll to **Set Password**, and then press **Enter**.
3. To set a password to the operator level, scroll to **Operator**. To set a password to the administrator level, scroll to **Administrator**.
4. Press **Enter**. If you are not logged in as Administrator, press **Enter** again to log in.
5. In the text box, scroll to the first character of the password. The cursor automatically appears at the first number of the password. At each position of the password, use the up and down arrows to change the value of each number. Press **Enter** to advance the cursor to the next number.
 **NOTE:** If you make a mistake, press **Escape** to backspace to the digit you want to change.
6. When you have entered six numbers, the autoloader displays `Submit Password`.
7. Press **Enter** to submit the password. `Password Successfully changed` appears on the LCD.
8. Press **Enter**. The Operator and Administrator options reappear. You can either enter another password, or press **Escape** or **Enter** as necessary to return to the main menu.

Getting Lost Passwords

If you forget the administrator-level password, you cannot access the autoloader's functionality to enter a new password. In this case, you must call support.dell.com. When you call, have the autoloader connected to the Ethernet and open the Remote Management Unit.

 **NOTE:** You can reset front panel passwords to the factory defaults from the Remote Management Unit. However, if the Remote Management Unit passwords are lost, you must contact support.dell.com. If you must contact support.dell.com, be at the host computer

with the Remote Management Unit on line. From the main screen, click **Configuration**. The **Enter Network Password or User name** screen displays. The customer support representatives will need the number surrounded by asterisks to locate and reset your password. This is your "realm number."

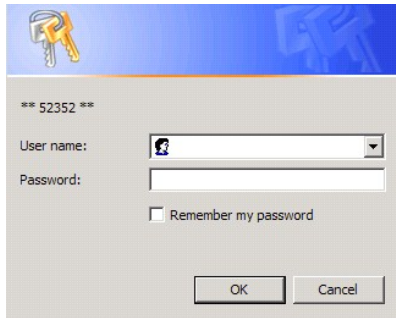

** 52352 **

User name:

Password:

Remember my password

OK Cancel

[Back to Contents Page](#)

[Back to Contents Page](#)

Diagnostics: Dell™ PowerVault™ 124T LTO-2 Autoloader User's Guide

• [Diagnostic Tests from the Front Panel](#)

• [Remote Management Unit Diagnostic Tests](#)

Diagnostic Tests from the Front Panel

Diagnostic tests allow you to calibrate parts of the autoloader, check the condition of parts, or test the autoloader's functionality. From the front panel, you can perform all of the diagnostic tests. Because certain tests require you to manually insert a minimum of 2 cartridges, you can perform only some of the diagnostic tests using the Remote Management Unit (see "[Remote Management Unit Diagnostic Tests](#)").

 **NOTE:** The Remote Management Unit allows you to request all diagnostic tests, but any tests that require a cartridge to be inserted will time-out unless someone manually inserts the cartridge at the appropriate time.

Setting the Security

When you enable the security function, the diagnostic tests are password protected to ensure data integrity. To access any of the diagnostic tests, you must first enter an Administrator password. If you do not enter the password, you will be prompted to enter the password when you attempt to perform a diagnostic test.

You can also enter passwords from the Command menu as follows:

1. From any menu, click the **Commands** heading. The **Commands** screen displays.
2. On the **Commands** submenu, scroll to **Enter Password**, and then press **Enter**.
3. On the **Enter Password** submenu, scroll to **Administrator**, and then press **Enter**.
4. In the text box, scroll to the first number of the password, and then press **Enter**.
5. Repeat step 4 to enter the remaining numbers of your password.

 **NOTE:** Press **Escape** to backspace to a previous text box, if necessary.

When you have finished entering your password, `submit Password` appears on the LCD below the asterisks.

6. Press **Enter** to submit your password. The display returns to the **Enter Password** submenu.

Stopping a Diagnostic Test

At times, you may need to stop a diagnostic test while it is in progress. To stop a diagnostic test while it is running, use the **End Curr. Test** function. When you select **End Curr. Test**, any picker or magazine functions complete, and then the diagnostic test stops.

To end a test from the front panel:

1. While the diagnostic test you wish to stop is running, press **Escape**. The **Diagnostics** submenu displays.
2. On the submenu, scroll to **End Curr. Test**, and then press **Enter**. `User Abort` displays.
3. Press **Enter** to return to the **Diagnostics** submenu. Refer to the Remote Management Unit for any test results.

To stop a test from the Remote Management Unit:

1. Select the **Stop Current Test** button in the **Diagnostics** test section of the Error Logs and Diagnostics page.
2. Select **View Status** to see the results of the command. `Test Stopped` displays along with any test results.

Front Panel Diagnostic Tests

You can perform the following diagnostic tests using the front panel:

1. Picker Test
1. Magazine Test
1. Inventory Test
1. Random Moves

To perform any of the front panel diagnostic tests:

1. From any menu, click the **Diagnostics** heading. The **Diagnostics** screen displays.
2. Scroll to the test you want to run and press **Enter**.

If you are already logged in as Administrator, the test begins executing immediately. The message **Running Test** appears while the test is running.

 **NOTE:** Each test takes from 30 seconds to several minutes to complete. To stop the test prematurely, see "[Stopping a Diagnostic Test](#)."

3. If you are not logged in, you will be asked to enter the Administrator password. Do the following:
 - o From the front panel, enter the administrator password by using the **Up** and **Down** scroll arrows to select each digit, and then press **Enter** to move to the next digit. To move to the previous digit, press **Escape**. When you have entered the entire six digit password, you will be asked to press **Enter** one more time to submit the password. If the password is incorrect, you will be asked to re-enter it using the same procedure. Otherwise, you will be returned to the **Diagnostics** menu. Press **Enter** to run the desired test.
- Running Test** appears while the test is in progress. To stop the test prematurely, see "[Stopping a Diagnostic Test](#)."
4. If the test is successful, press **Enter** to return to the **Diagnostic** test menu. For detailed results of a test, use the Remote Management Unit to retrieve the diagnostic test status (see "[Running Diagnostic Tests](#)").

Remote Management Unit Diagnostic Tests

Because some of the diagnostic tests require you to insert a minimum of two cartridges into the autoloader, you cannot perform these tests from a remote location. You can perform the following diagnostic tests from the Remote Management Unit:

- 1 Loader - Picker Test
- 1 Loader - Magazine Test
- 1 Loader - Inventory Test
- 1 Random Moves

 **NOTE:** The Remote Management Unit allows you to request all diagnostic tests, but any tests that require a cartridge to be inserted will time-out unless someone manually inserts the cartridge at the appropriate time.

Diagnostics Using the Remote Management Unit

Many tests can be run using the Remote Management Unit. To perform the Remote Management Unit diagnostic tests:

1. Open a Web browser and connect to the autoloader. The Remote Management Unit main menu appears.
2. Click the **Error Logs and Diagnostics** heading. A login window appears.
3. Type an Administrator user name and a password, and then click **Enter**. The **Diagnostics** submenu appears.
4. Select the test you wish to perform from the **Diagnostics** drop-down menu, and then click **submit**.

The selected diagnostic test runs. While the test is running, you can view the status of the test. To view the status, from the **View Diagnostic Test Progress** section, click **View Status**.

[Back to Contents Page](#)

[Back to Contents Page](#)

Getting Help: Dell™ PowerVault™ 124T LTO-2 Autoloader User's Guide

- [Technical Assistance](#)
 - [Dell Enterprise Training and Certification](#)
 - [Problems With Your Order](#)
 - [Product Information](#)
 - [Returning Items for Warranty Repair or Credit](#)
 - [Before You Call](#)
-

Technical Assistance

If you need assistance with a technical problem, perform the following steps:

1. Complete the procedures in "[Before Contacting Customer Support](#)".
2. Run the system diagnostics and record any information provided.
3. Use Dell's extensive suite of online services available at Dell Support at support.dell.com for help with installation and troubleshooting procedures.

For more information, see "Online Services."

4. If the preceding steps have not resolved the problem, call Dell for technical assistance.

 **NOTE:** Call technical support from a phone near or at the system so that technical support can assist you with any necessary procedures.

 **NOTE:** Dell's Express Service Code system may not be available in all countries.

When prompted by Dell's automated telephone system, enter your Express Service Code to route the call directly to the proper support personnel. If you do not have an Express Service Code, open the **Dell Accessories** folder, double-click the "**Express Service Code**" icon, and follow the directions.

For instructions on using the technical support service, see "[Technical Support Service](#)" and "[Before You Call](#)."

 **NOTE:** Some of the following services are not always available in all locations outside the continental U.S. Call your local Dell representative for information on availability.

Online Services

You can access Dell Support at support.dell.com. Select your region on the **WELCOME TO DELL SUPPORT** page, and fill in the requested details to access help tools and information.

You can contact Dell electronically using the following addresses:

- 1 World Wide Web

www.dell.com/

www.dell.com/ap (Asian/Pacific countries only)

www.dell.com/jp (Japan only)

www.euro.dell.com (Europe only)

www.dell.com/la (Latin American countries)

www.dell.ca (Canada only)

- 1 Anonymous file transfer protocol (FTP)

ftp.dell.com/

Log in as user: `anonymous`, and use your e-mail address as your password.

- 1 Electronic Support Service

support@us.dell.com

apsupport@dell.com (Asian/Pacific countries only)

support.jp.dell.com (Japan only)

support.euro.dell.com (Europe only)

- 1 Electronic Quote Service

sales@dell.com

apmarketing@dell.com (Asian/Pacific countries only)

sales_canada@dell.com (Canada only)

- 1 Electronic Information Service

info@dell.com

AutoTech Service

Dell's automated technical support service — AutoTech — provides recorded answers to the questions most frequently asked by Dell customers about their portable and desktop computer systems.

When you call AutoTech, use your touch-tone telephone to select the subjects that correspond to your questions.

The AutoTech service is available 24 hours a day, 7 days a week. You can also access this service through the technical support service. See the contact information for your region.

Automated Order-Status Service

To check on the status of any Dell™ products that you have ordered, you can go to support.dell.com, or you can call the automated order-status service. A recording prompts you for the information needed to locate and report on your order. See the contact information for your region.

Technical Support Service

Dell's technical support service is available 24 hours a day, 7 days a week, to answer your questions about Dell hardware. Our technical support staff use computer-based diagnostics to provide fast, accurate answers.

To contact Dell's technical support service, see "[Before You Call](#)" and then see the contact information for your region.

Dell Enterprise Training and Certification

Dell Enterprise Training and Certification is available; see www.dell.com/training for more information. This service may not be offered in all locations.

Problems With Your Order

If you have a problem with your order, such as missing parts, wrong parts, or incorrect billing, contact Dell for customer assistance. Have your invoice or packing slip available when you call. See the contact information for your region.

Product Information

If you need information about additional products available from Dell, or if you would like to place an order, visit the Dell website at www.dell.com. For the telephone number to call to speak to a sales specialist, see the contact information for your region.

Returning Items for Warranty Repair or Credit

Prepare all items being returned, whether for repair or credit, as follows:

1. Call Dell to obtain a Return Material Authorization Number, and write it clearly and prominently on the outside of the box.

For the telephone number to call, see the contact information for your region.

2. Include a copy of the invoice and a letter describing the reason for the return.
3. Include a copy of any diagnostic information indicating the tests you have run and any error messages reported by the system diagnostics.
4. Include any accessories that belong with the item(s) being returned (such as power cables, media such as CDs and diskettes, and guides) if the return is for credit.
5. Pack the equipment to be returned in the original (or equivalent) packing materials.

You are responsible for paying shipping expenses. You are also responsible for insuring any product returned, and you assume the risk of loss during shipment to Dell. Collect-on-delivery (C.O.D.) packages are not accepted.

Returns that are missing any of the preceding requirements will be refused at our receiving dock and returned to you.

Before You Call

 **NOTE:** Have your Express Service Code ready when you call. The code helps Dell's automated-support telephone system direct your call more efficiently.

If possible, turn on your system before you call Dell for technical assistance and call from a telephone at or near the computer. You may be asked to type some commands at the keyboard, relay detailed information during operations, or try other troubleshooting steps possible only at the computer system itself. Ensure that the system documentation is available.

 **CAUTION:** Before servicing any components inside your computer, see your *Product Information Guide* for important safety information.

[Back to Contents Page](#)

Installing the Autoloader: Dell™ PowerVault™ 124T LTO-2 Autoloader User's Guide

- [Installation Overview](#)
 - [Installation Preparation](#)
 - [SCSI Bus Requirements](#)
 - [Accessories](#)
 - [Choosing a Location](#)
 - [UL Requirements](#)
 - [Bar Code Reader](#)
 - [Product Overview](#)
 - [Unpacking the Autoloader](#)
 - [Identifying Product Components](#)
 - [Connecting the SCSI and Power Cables](#)
 - [Preparing the Host and Verifying the Connection](#)
 - [Installing the Device Drivers](#)
 - [Enabling LUN Support in Linux](#)
 - [Enabling LUN Support in Netware](#)
-

Installation Overview

Installing the autoloader consists of the following steps, which are explained in more detail later in this section:

1. Prepare to install your new Dell PowerVault 124T LTO-2 autoloader (see "[Installation Preparation](#)").
 2. Identify the proper SCSI bus types (see "[SCSI Bus Requirements](#)").
 3. Identify the accessories that come with the autoloader (see "[Accessories](#)").
 4. Install the autoloader in a computer rack near the host server. If installing a rack mount unit, refer to your rack *Installation Guide*.
 5. Shut down or turn off the server and all devices attached to the server (see "[Connecting the SCSI and Power Cables](#)").
 6. Attach the SCSI cable to the autoloader and server's SCSI host adapter (see "[Connecting the SCSI and Power Cables](#)").
 7. Attach the power cable to the autoloader and plug in the power cable to the nearest power outlet (see "[Connecting the SCSI and Power Cables](#)"). Power the autoloader on to ensure it passes the Power-on Self-Test (POST).
 8. Set the SCSI ID for the autoloader (see "[Setting the SCSI ID](#)").
 9. Set up the host and verify the connection (see "[Preparing the Host and Verifying the Connection](#)").
-

Installation Preparation

Before you install your new Dell PowerVault 124T LTO-2 autoloader, unpack it carefully and inspect it for any damage that might have occurred during shipping. The *Getting Started Guide* included in the packaging describes all the necessary information to unpack and inspect your autoloader correctly. Locate the *Getting Started Guide* and follow the directions.

Ensure that the work area is free from conditions that could cause electrostatic discharge (ESD). Discharge static electricity from your body by touching a known grounded surface, such as your computer's metal chassis.

SCSI Bus Requirements

You must connect the Dell PowerVault 124T LTO-2 autoloader to one of the following SCSI bus types:

- 1 Ultra 160 SCSI, Low-voltage Differential (LVD)
- 1 Ultra 320 SCSI, Low-voltage Differential (LVD)
- 1 Single-ended (SE) SCSI bus

 **NOTE:** The Dell PowerVault 124T LTO-2 autoloader is not compatible with a High-voltage Differential (HVD) SCSI bus.

Your SCSI host adapter card must also support the SCSI bus type used to connect the autoloader. If you use a LVD SCSI bus, use a host adapter card with a connection for a high-density (HD) 68-pin cable.

 **NOTE:** If you use an SE SCSI bus, the tape drive's performance is limited to the maximum data transfer speed of the bus.

 **NOTE:** The maximum number of autoloaders supported per SCSI bus is two.

 **NOTE:** The autoloader may not work with multiple SCSI LUNS when attached to a redundant array of independent disks (RAID) controller. The autoloader is not recommended for use with a RAID controller. If this problem occurs, it is recommended that the autoloader be attached to a separate SCSI bus controller on the server.

Accessories

The following accessories are shipped with the Dell PowerVault 124T LTO-2 autoloader:

- 1 *Getting Started Guide*
- 1 SCSI host cable
- 1 SCSI terminator
- 1 Hardware to rack mount the autoloader (autoloader rails are included, rack rails are optional)
- 1 One magazine blank
- 1 Power cable
- 1 Documentation CD containing all of the documentation in Adobe® Portable Document Format (PDF) and supplied device drivers

- 1 Bar code labels
- 1 TORX L-key drivers (T8 and T10)
- 1 Emergency Magazine Removal Tool

Choosing a Location

Choose a location that meets the following criteria (see "[Technical Specifications](#)"):

 **NOTICE:** Do not place the autoloader on its side or upside down. Do not stack anything on top of the autoloader.

Rack Requirements Standard 19-inch rack with 2U (3.5 in.) of clearance.

Room Temperature 10–35°C (50–95°F)

Power Source AC power voltage: 100–127 VAC; 200–240 VAC
Line frequency: 50–60 Hz

 **NOTE:** Locate the AC outlet near the autoloader. The AC power cable is the product's main AC disconnect device and must be easily accessible at all times.

Weight 14.1 kg (31 lb) unloaded
17.2 kg (38 lb) loaded (2 magazines, 16 cartridges)

Air Quality Minimize sources of particulate contamination. Avoid areas near frequently used doors and walkways, cooling or exhaust vents, stacks of supplies that collect dust, printers, and smoke-filled rooms. Avoid placing on or near the floor, or in a carpeted room.

 **NOTICE:** Excessive dust and debris can damage tapes and tape drives.

Humidity 20–80% RH (noncondensing)

Clearance Back: Minimum of 43.2 cm (17 in)
Front: Minimum of 68.6 cm (27 in)
Sides: Minimum of 5.08 cm (2 in)

UL Requirements

Elevated Operating Ambient Temperature When installed in a closed or multi-unit rack assembly, the operating ambient temperature of the rack environment may be greater than the room ambient. You must install the equipment in an environment compatible with the manufacturer's maximum recommended ambient temperature.

Reduced Air Flow Installation of the equipment in a rack should be such that the amount of air flow required for safe operation of the equipment is not compromised.

Mechanical Loading Mounting of the equipment in a rack should be such that a hazardous condition is not achieved due to uneven mechanical loading.

Overloading the Circuit Consideration should be given to the connection of the equipment to the supply circuit and the effect that overloading of circuits might have on overcurrent protection and supply wiring. Appropriate consideration of equipment nameplate ratings should be used when addressing the concern.

Reliable Grounding Reliable grounding of rack-mounted equipment should be maintained. Particular attention should be given to supply connections other than direct connections to the branch circuit, such as use of power strips.

Bar Code Reader

Your autoloader is equipped with a bar code reader. The bar code reader is enclosed within the body of the autoloader and automatically scans each cartridge in the magazine upon power up, after a reset, after an import or export, or when a re-inventory command is issued (see "[Running Inventory](#)"). The information from each label is stored in memory and available through SCSI and the Remote Management Unit to the computer's operating system or backup application upon request. The bar code reader can be disabled through the operator control panel or the web user interface. This feature allows faster initialization of the unit if non-bar code labels or no labels are used on the cartridge.

If utilizing the bar code reader, you must apply the bar code labels into the slot on the front of each cartridge. The labels must conform to ANSI/AIM BC1 -1995 Uniform Symbology Specification Code 39. A set of bar code labels is initially included with the autoloader. Refer to www.dell.com for information on obtaining additional bar code labels.

Product Overview

Front Panel Controls

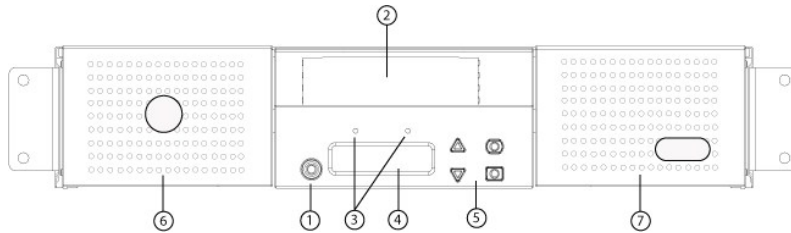

- 1 Power switch
- 2 Media door (mailslot)
- 3 Front panel LEDs
- 4 Front panel LCD screen
- 5 Function keys
- 6 Left magazine
- 7 Right magazine (or blank)

Back Panel Overview

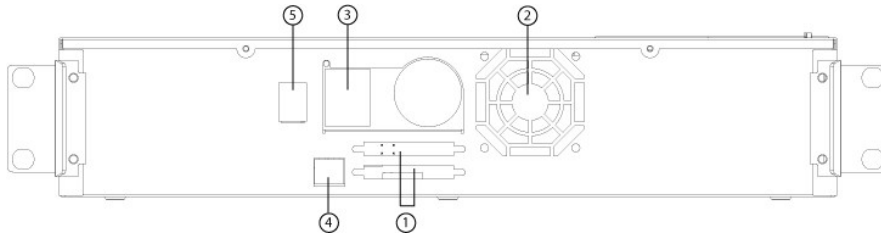

- 1 68-pin HD SCSI connectors
- 2 Fan vent
- 3 Power connector
- 4 Ethernet connector
- 5 Power switch

NOTE: If the cover must be taken off, there are 26 screws and 6 rail bolts that need to be removed. The cover should be removed only by a qualified Dell Service Provider.

Unpacking the Autoloader

Before you begin, clear a desk or table so that you can unpack the autoloader. You also need to select an open 2U computer rack location near the server that will host the autoloader.

NOTICE: If the room in which you are working differs from the temperature in which the autoloader was shipped or stored by 15°C (30° F) or more, let the autoloader acclimate to the surrounding environment for at least 12 hours before opening the shipping carton.

Unpack and inspect the autoloader for shipping damage by doing the following:

1. Clear a table or desk so that you have room to unpack the autoloader.
2. Inspect the shipping box for damage. If you notice any damage, report it to the shipping company immediately.
3. Open the shipping box and remove the accessories package. Set the accessories package aside for now.
4. Lift the autoloader and padding out of the box and place it on the work surface, top facing up. *Do not set the autoloader on either end or sides.*
5. Carefully remove the shipping padding from the front and back sides of the autoloader. Then remove the bag from the autoloader. *Save the packing materials in case you need to move or ship the autoloader in the future.*

Identifying Product Components

Accessories

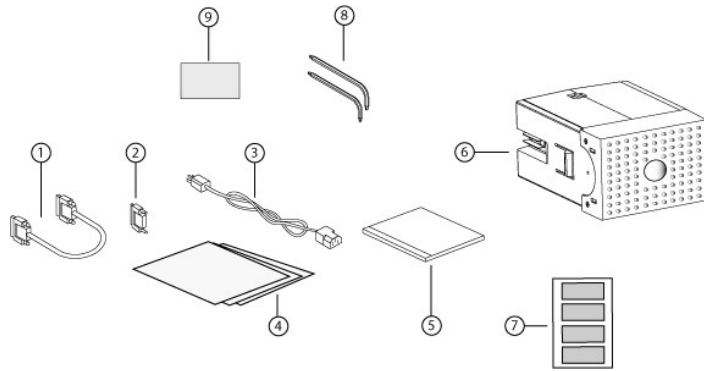

- 1 SCSI cable
- 2 SCSI terminator
- 3 Power cable
- 4 *Getting Started Guide*
- 5 CD (drivers and documentation)
- 6 Magazine blank
- 7 Bar code labels
- 8 TORX L-key drivers (T8 and T10)
- 9 Emergency Magazine Removal Tool

Connecting the SCSI and Power Cables

To connect the SCSI and power cables to the autoloader, follow these steps:

1. Shut down and turn off the selected server. Turn off all attached accessory devices, such as printers and other SCSI devices.
2. Attach one end of the SCSI cable (included in the accessory kit) to one of the connectors on the back panel of the autoloader.
3. Attach the other end of the SCSI cable to the connector on the SCSI host adapter or to the connector on the previous device on the SCSI bus.

If the supplied SCSI cable does not fit the connector on your SCSI host adapter, you either have an incompatible SCSI host adapter or you need to purchase a cable adapter. Contact your service representative or your SCSI host adapter manufacturer for information.

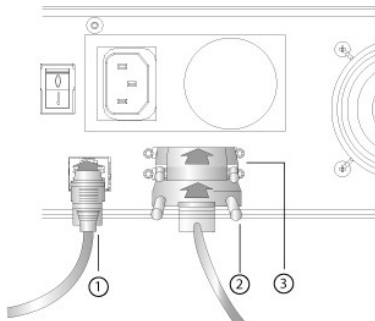

- 1 Ethernet cable
- 2 SCSI cable
- 3 SCSI terminator

4. Attach the terminator to the remaining SCSI connector on the back panel of the autoloader (if the autoloader is the last or only device on the SCSI bus). Otherwise, attach the cable to the next device on the SCSI bus. Make sure that the last device on the SCSI bus is properly terminated.
5. Attach the female connector of the power cable to the power connector on the back panel of the autoloader.
6. Plug in the power cable to the nearest properly grounded power outlet.
7. Plug in the host server or workstation and all attached devices.

8. Turn on the autoloader by setting the power switch on the back panel to the ON position. Turn on any other devices you turned off earlier. Check the LCD screen to make sure the autoloader is receiving power. If it is not, check the power connections and your power source.

During the Power-on Self-Test (POST), both LEDs are illuminated briefly, followed by only the Ready/Activity LED flashing. When the initialization sequence is complete, the LCD screen displays the Home screen.

9. Turn on the server.

Preparing the Host and Verifying the Connection

If necessary, install a SCSI host adapter, software, and compatible drivers. Refer to the manuals for the host computer and SCSI host adapter for detailed instructions. In addition, follow these general guidelines:

- 1 When the host server is powered on, install software, and/or drivers that are compatible with the autoloader (see "[Installing the Device Drivers](#)"). Software compatibility information is available at support.dell.com. Most backup software packages require an additional module to communicate with the autoloader robotics.
 - 1 If the host server is connected to a network, check with the system administrator before turning off power.
 - 1 Use proper procedures to prevent electrostatic discharge (ESD). Use wrist-grounding straps and anti-static mats when handling internal components.
 - 1 Make sure that the host server has an open expansion slot.
 - 1 Make sure that your backup application supports the SCSI host adapter.
 - 1 Depending on the server configuration, you may need to change the SCSI ID of the autoloader (see "[Setting the SCSI ID](#)").
 - 1 Ensure the autoloader is properly terminated. If the autoloader is the only SCSI device—other than the SCSI host adapter—on the selected SCSI bus, it must be terminated. Likewise, if the autoloader is physically the last SCSI device on the SCSI bus, it must be terminated. Only the devices physically at the beginning and end of the SCSI bus should be terminated. If the host is located at the beginning of the SCSI bus, the host should already have a terminator installed.
 - 1 Verify the connection between the autoloader and host by going to **Settings>Control Panel>System>Hardware>Device Manager>Tape Drive** and/or **Media Changer** in Microsoft® Windows® 2000, Microsoft Windows XP and Windows Server® 2003. For more information on verifying the connection of SCSI devices, consult the operating system documentation.
-

Installing the Device Drivers

There are two device drivers associated with the Dell PowerVault 124T LTO-2 autoloader. One for the autoloader itself, and a second for the LTO-2 tape drive within the autoloader.

 **NOTE:** The device drivers supplied on the *Dell PowerVault 124T LTO-2 Autoloader User's Manual and Drivers* CD are required if you intend to use the Microsoft Windows native backup application. Commercial backup applications provide all necessary device driver support. Refer to support.dell.com for a list of compatible backup applications.

Tape Drive Device Driver

Microsoft Windows 2000:

1. Make sure that you are logged on to the host server with administrator privileges.
2. Insert the *Dell PowerVault 124T Autoloader User's Manual and Drivers* CD into the CD drive on the host computer.
3. Open the device manager (refer to your specific OS documentation for instructions). For example, right-click the **My Computer** icon on the Windows desktop, click **Manage**, and then click **Device Manager**.

The LTO-2 drive should be listed under the **? Other Devices** item as **CERTANCE ULTRIUM 2 SCSI Sequential Device**.

4. Right-click the **CERTANCE ULTRIUM 2 SCSI Sequential Device** listing and click **Properties**.
5. Select the **Driver** tab.
6. Click **Update Driver**.
7. When the Upgrade Device Driver Wizard appears, click **Next**.
8. Click **Display a list...** and then click **Next**.
9. Scroll down and click **Tape Drive**, and then click **Next**.
10. Click **Have Disk**, type `D:\Drivers\Drive`, replacing `d:` with the drive letter for the CD drive into which you inserted the *Dell PowerVault 124T Autoloader User's Manual and Drivers* CD, and then click **OK**.
11. Click the **CERTANCE ULTRIUM 2 SCSI Sequential Device** entry, and then click **Next**.
12. Click **Next** to install the driver.
13. Click **Finish**.
14. Click the **Device Properties** dialog box.

The drive now appears in **Device Manager** under **Tape Drives** as a **CERTANCE ULTRIUM 2 SCSI Sequential Device** and is ready to use.

Microsoft Windows Server 2003:

1. Make sure that you are logged on to the host server with administrator privileges.
2. Insert the *Dell PowerVault 124T Autoloader User's Manual and Drivers* CD into the CD drive on the host computer.

3. Open the device manager (refer to your specific OS documentation for instructions). For example, right-click the **My Computer** icon on the Windows desktop, click **Properties**, and then click **Device Manager** or by going to the **Control Panel** and opening **System**. Select **Hardware**, then click **Device Manager**.

The LTO-2 drive should be listed under the ? **Other Devices** item as **CERTANCE ULTRIUM 2 SCSI Sequential Device**.

4. Right-click the **CERTANCE ULTRIUM 2 SCSI Sequential Device** listing and click **Properties**.
5. Select the **Driver** tab.
6. Click **Update Driver**.
7. When the Upgrade Device Driver Wizard appears, click **Next**.
8. Click **Display a list...** and then click **Next**.
9. Scroll down and click **Tape Drive**, and then click **Next**.
10. Click **Have Disk**, type `d:\Drivers\Drive`, replacing `d:` with the drive letter for the CD drive into which you inserted the *Dell PowerVault 124T Autoloader User's Manual and Drivers* CD, and then click **OK**.
11. Click the **CERTANCE ULTRIUM 2 SCSI Sequential Device** entry, and then click **Next**.
12. Click **Next** to install the driver.
13. Click **Finish**.
14. Click the **Device Properties** dialog box.

The drive now appears in **Device Manager** under **Tape Drives** as a **CERTANCE ULTRIUM 2 SCSI Sequential Device** and is ready to use.

Autoloader Device Driver

Microsoft Windows 2000:

1. Make sure that you are logged on to the host server with administrator privileges.
2. Insert the *Dell PowerVault 124T Autoloader User's Manual and Drivers* CD into the CD drive on the host server.
3. Right-click the **My Computer** icon on the Windows desktop, click **Manage**, and then click **Device Manager**.
The autoloader should be listed under **Medium Changers** as **Unknown Medium Changer Device**.
4. Right-click the **Unknown Medium Changer Device** listing and click **Properties**.
5. Select the **Driver** tab.
6. When the Upgrade Device Driver Wizard appears, click **Next**.
7. Click **Display a list...** and then click **Next**.
8. Click **Have Disk**, type `d:\Drivers\Autoloader`, replacing `d:` with the drive letter for the CD drive into which you inserted the *Dell PowerVault 124T Autoloader User's Manual and Drivers* CD, and then click **OK**.
9. Click the **Dell (tm) PowerVault (tm) 124T Autoloader** entry and click **Next**.
10. Click **Next** again to install the driver.
11. Click **Finish**.
12. Close the **Device Properties** dialog box.

The autoloader now appears in **Device Manager** under **Medium Changers** as a **Dell (tm) PowerVault (tm) 124T Autoloader**, and is ready to use.

Microsoft Windows Server 2003:

1. Make sure that you are logged on to the host server with administrator privileges.
2. Insert the *Dell PowerVault 124T Autoloader User's Manual and Drivers* CD into the CD drive on the host server.
3. Right-click the **My Computer** icon on the Windows desktop, click **Manage**, and then click **Device Manager**.
The autoloader should be listed under **Medium Changers** as **Unknown Medium Changer Device**.
4. Right-click the **Unknown Medium Changer Device** listing and click **Properties**.
5. Select the **Driver** tab.
6. When the Upgrade Device Driver Wizard appears, click **Next**.
7. Click **Display a list...** and then click **Next**.
8. Click **Have Disk**, type `d:\Drivers\Autoloader`, replacing `d:` with the drive letter for the CD drive into which you inserted the *Dell PowerVault 124T Autoloader User's Manual and Drivers* CD, and then click **OK**.

9. Click the **Dell (tm) PowerVault (tm) 124T Autoloader** entry and click **Next**.
10. Click **Next** again to install the driver.
11. Click **Finish**.
12. Close the **Device Properties** dialog box.

The autoloader now appears in **Device Manager** under **Medium Changers** as a **Dell (tm) PowerVault (tm) 124T Autoloader**, and is ready to use.

Enabling LUN Support in Linux

To verify the detection of a tape drive, administrators should check for its entry in `/proc/scsi/scsi`. Current versions of Linux may not scan the logical storage unit (LUN) ID of every device. This can result in some PowerVault devices not being identified or listed in the `/proc/scsi/scsi` output. Administrators can follow these steps to enable support for such devices.

1. Type `cat /proc/scsi/scsi`. The output will look similar to the following:

```
Attached devices:
Host: scsi3 Channel: 00 Id: 00 Lun: 00
Vendor:  CERTANCE Model: ULTRIUM 2      Rev: 1826
Type:    Sequential-Access              ANSI SCSI revision: 03
```

2. Identify the host adapter, channel number, target ID number, and LUN number for the first LUN of the device to be configured. In this example, the Certance Ultrium 2 (a drive in the PowerVault 124T) is shown at the address, or nexus, 3 0 0 0 — which means host adapter 3, channel number 0, ID 0, and LUN 0. The PowerVault 124T always has the tape drive at LUN 0 and the robot at LUN 1.
3. For each LUN that needs to be discovered by Linux, issue the following command:

```
echo "scsi-add-single-device H C I L">/proc/scsi/scsi
```

H C I L refers to the nexus described in [step 2](#). So, with the PowerVault 124T robot configured at LUN 1, type:

```
echo "scsi-add-single-device 3 0 0 1">/proc/scsi/scsi
```

The echo command will force a scan of each device at the given nexus.

4. Type `cat /proc/scsi/scsi` again to verify that all devices are now listed. The output will look similar to the following:

```
Attached devices:
Host: scsi3 Channel: 00 Id: 00 Lun: 00
Vendor:  CERTANCE Model: ULTRIUM 2      Rev: 1826
Type:    Sequential-Access              ANSI SCSI revision: 03

Attached devices:
Host: scsi3 Channel: 00 Id: 00 Lun: 01
Vendor:  DELL Model: PV-124T           Rev: V31
Type:    Sequential-Access              ANSI SCSI revision: 03
```

Administrators should add the echo command to the Linux boot scripts because the device information is not persistent and must be created each time the system boots up. One example file that can be used for storing the commands is `/etc/rc.local`. Note that configuring additional devices on a server or a storage area network (SAN) can cause the devices to be reordered, which requires administrators to modify the commands. If the Fibre Channel adapter supports Persistent Bindings or an equivalent function, it can be enabled to reduce the chance of devices being reordered upon discovery.

 **NOTE:** This procedure must be run each time the server is booted. Also, if backup application services are running (for example, they automatically start when the OS loads), they must be disabled and re-enabled after the above procedure.

The other way to enable LUN support is to recompile the kernel and enable LUN scanning in the Adaptec driver, but it requires advanced knowledge of Linux and will not be covered here. However, it will allow the server to always boot and see the device without any manual procedures.

Enabling LUN Support in Netware

1. From the System Console, verify the LUN device is not being detected by using the list storage adapters command.

Typical output where only the tape drive is being recognized:

```
0x08 [V321-A3] Adaptec SCSI Card 39160/3960D - Ultra160 SCSI [slot 201]
0x15 [V321-A3-D5:0] CERTANCE ULTRIUM 2 1826
0x09 [V321-A4] Adaptec SCSI Card 39160/3960D - Ultra160 SCSI [slot 202]
```

2. From the System Console, type `nwconfig`.
3. Select **NCF files Options** from the Configuration Options screen.
4. Select **Edit STARTUP.NCF** from the Available NCF Files Options screen.
5. Add the `/LUNS` switch to the load line of the appropriate SCSI driver. If a dual channel card is installed and the user is unsure which channel the LUN

device is attached to, simply edit both lines.

```
LOAD ADPT160M.HAM SLOT=201 /LUNS
LOAD ADPT160M.HAM SLOT=202 /LUNS
```

6. After the STARTUP.NCF file has been edited, save the file and reboot the server to activate the new STARTUP.NCF.
7. Upon reboot navigate to the System Console and type `scan all`. This will start a scan of all the LUNS on each adapter.
8. When the scan is complete, verify the LUN device has been detected using the `list storage adapters` command.

Typical output with both the tape drive and loader being recognized:

```
0x08 [V321-A3] Adaptec SCSI Card 39160/3960D - Ultra160 SCSI [slot 201]
  0x16 [V321-A3-D5:1] DELL PV-124T 0031
  0x15 [V321-A3-D5:0] CERTANCE ULTRIUM 2 1826
0x09 [V321-A4] Adaptec SCSI Card 39160/3960D - Ultra160 SCSI [slot 202]
```

Netware may display **unbound device**, meaning a driver is not bound to the loader unless a driver from a backup software is loaded. This does not prevent the backup application from detecting the LUN and binding the appropriate driver.

 **NOTE:** The user must type the command `scan all` upon OS boot every time. If backup software services automatically start on OS boot, the user must disable them, run the `scan all` command, and re-enable the services.

 **NOTE:** Netware may display **unbound device** meaning a driver is not bound to the loader unless a driver from a backup software is loaded. This does not prevent the backup application from detecting the LUN and binding the appropriate driver.

[Back to Contents Page](#)

[Back to Contents Page](#)

Introduction: Dell™ PowerVault™ 124T LTO-2 Autoloader User's Guide

Overview

Data backup is essential to protect irreplaceable information. Backing up data to magnetic tape is an easy, cost-efficient method used by many small and medium businesses. However, most enterprises have so much data that a single backup tape is not enough: the information has to be spread across numerous tapes. To avoid constantly changing tapes manually, many tape backup solutions include a PowerVault 124T LTO-2 autoloader.

Each autoloader is a device that includes a robot, a tape drive and one or two magazines for tape cartridges. The user's application can automatically load and unload tape cartridges as required for data backup or data retrieval. Dell PowerVault 124T LTO-2 autoloaders provide a compact, high capacity, but low cost method for easy, unattended data backup.

The PowerVault 124T LTO-2 contains a Quantum LTO-2 half-height tape drive, and one or two magazines that can hold up to eight cartridges each. The user can insert a single cartridge directly through a media door (mailslot) that can be password protected. From the media door (mailslot), the user can insert the cartridge into the tape drive provided there is no cartridge already in the drive, or into a magazine slot provided there is no cartridge already in the slot.

The front panel on the autoloader includes a liquid crystal display (LCD) screen and four function keys. A scrolling menu on the LCD screen allows the user to obtain information from the autoloader and enter commands. The front panel also includes two light emitting diodes (LEDs) indicating the autoloader's ready status and error status.

The PowerVault 124T LTO-2 connects to the user's host server through a Small Computer System Interface (SCSI) connection allowing the host to send data and commands automatically. The unit also can connect to an Ethernet which allows the user to perform administrative functions and download system updates.

The autoloader is SCSI-3 compatible and operates as a single SCSI ID/two LUN data storage device and provides a compressed capacity of 6.4 Terabytes and a sustained data transfer rate of 93.6 GB per hour (native) or as high as 187.2 GB per hour compressed (assuming 2:1 compression).

The autoloader is compatible with the most popular operating systems and environments supporting an Ultra 160 SCSI or an Ultra 320 SCSI LVD interface but requires direct support from the operating system or a compatible backup application to take full advantage of its many features.

[Back to Contents Page](#)

Operating the Autoloader: Dell™ PowerVault™ 124T LTO-2 Autoloader User's Guide

- [Operator's Panel Functionality](#)
- [Using Cartridges](#)
- [Using Magazines and Magazine Blanks](#)
- [Viewing Status Information](#)
- [Running an Inventory](#)
- [Data Compression](#)

Operator's Panel Functionality

 **NOTE:** If security is enabled and you try to execute a command without entering a password, the autoloader displays the **Enter Password** screen until you enter a password. Once you enter a password, the autoloader takes you back to the command screen that you were at prior to entering the password.

The Operator's Panel consists of two LEDs, five buttons, and a 2-line by 16-character LCD screen. The Operator's Panel provides everything you need to monitor autoloader status and to control all of its functions.

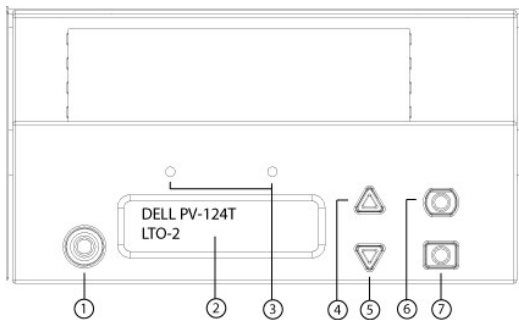

- 1 Power switch
- 2 Front panel LCD screen
- 3 Front panel LEDs
- 4 Scroll up button
- 5 Scroll down button
- 6 Escape
- 7 Enter

All the functionality accessed from the scrolling menu can be password-protected. Two levels of security are built into the menu. The lower-level security is the operator level and the higher-level security is the administrator level. There is one password for each level.

The administrator password allows access to all the functionality available. The operator password allows access to all the functionality in the **Command** and **Status** submenus.

Enter Passwords

Many functions on the autoloader may be password-protected to ensure data integrity. To access the menu items necessary to execute these functions, you must first enter your password (see "[Setting Passwords](#)"). All passwords are six numeric digits long. These passwords are specific to the front panel and are different from Remote Management Unit (RMU) passwords.

When you enter a password, all password-protected functionality is available until you log out (see "[Logout](#)"). If you do not use the front panel for a period of time, the main screen reappears on the LCD. When the main screen reappears, the autoloader has automatically logged you out. You will have to re-enter your password again to access the menu functionality.

Logout

To logout of the autoloader, use the following procedure.

1. From the main menu, scroll to **Commands**, and then press **Enter**.
2. From the **Commands** submenu, scroll to **Log Out**, and then press **Enter**. *Session Complete* appears on the LCD.



NOTE: You can also press **Escape** to log out. Continue pressing **Escape** as required until the main screen appears.

Using Cartridges

Typically, when you first install the autoloader, you load your cartridges into the magazines and then load the magazines into the autoloader. However, you can insert and eject cartridges individually using the media door (mailslot), or you can eject a magazine, manually load and unload cartridges, then load the magazine back into the autoloader. The autoloader automatically detects the presence of a cartridge in the magazine slot.



NOTE: On the front panel menu, whenever you see **Enter** or **Eject**, it means the tape enters and leaves the autoloader through the media door (mailslot). Whenever you see **Load** or **Unload**, it means the tape is loaded into or unloaded from the tape drive.

If you try to perform an illegal operation, the autoloader refuses to perform the operation. For example, if you try to load a cartridge through the media door (mailslot) to the drive but the drive already contains a cartridge, the media door (mailslot) does not unlock and will display an error message. If you try to unload a cartridge from the drive while the autoloader is writing to the tape, the command will not be initiated until the write command is completed.

Insert a Single Cartridge

When you want to load a single cartridge into the autoloader, you can use the media door (mailslot). However, if the Security option is turned on, you have to enter a valid password to unlock the media door (mailslot) before you can load a cartridge. When you insert a cartridge through the media door (mailslot), you can load it into the tape drive or store it in a magazine.

To insert a cartridge in the tape drive:

1. From the main menu, scroll to **Commands**, and then press **Enter**.
2. From the **Commands** submenu, scroll to **Enter-Mailslot**, and then press **Enter**.
3. From the **Enter-Mailslot** submenu, scroll to **To Drive**, and then press **Enter**.



NOTE: After **Insert Tape, Push Until Prompted** appears on the LCD, you have 40 seconds to load a cartridge through the media door (mailslot) before it relocks and "User Aborted" appears on the operator control panel.



NOTE: For the PowerVault 124T, push in the cartridge until you meet resistance. The cartridge will be about 2 inches (5.0 cm) inside the media door (mailslot), and only the end of the cartridge will be visible through the media door (mailslot).

4. Once you have inserted the cartridge, the prompt **Enter to continue** appears. You have 5 seconds to press **Enter** in response or the autoloader will automatically load the cartridge.



NOTE: If the insert cartridge function fails, the cartridge ejects and you will have to perform steps 3 and 4 again. A "Missed Tape" error message will be displayed on the operator control panel.

To insert a cartridge in a magazine slot:

1. From the main menu, scroll to **Commands**, and then press **Enter**.
2. From the **Commands** submenu, scroll to **Enter-Mailslot**, and then press **Enter**.
3. From the **Enter-Mailslot** submenu, scroll to **To Location**, and then press **Enter**.

Scroll through the magazine slots and view their status until you find the appropriate slot. Slots that are occupied by a data cartridge are indicated by an asterisk (*). A slot assigned for and occupied by a cleaning cartridge will be indicated by an at sign (@). An empty slot assigned to a cleaning cartridge will be indicated by an exclamation point (!).

4. Scroll to the slot where you want to store the cartridge, and then press **Enter**.

After **Load cartridge** appears on the LCD, you have 40 seconds to load a cartridge through the media door (mailslot) before it relocks. The autoloader automatically loads the cartridge into the selected slot.



NOTE: If the load cartridge function fails, the cartridge ejects and you will have to perform steps 3 and 4 again.

5. Once you have inserted the cartridge, the prompt **Enter to continue** appears. You have 5 seconds to press **Enter** in response or the autoloader will automatically load the cartridge.

Moving a Single Cartridge

You can easily move a single cartridge from one location to another inside the autoloader.

1. From the main menu, scroll to **Commands**, and then press **Enter**.
2. From the **Commands** submenu, scroll to **Move**, and then press **Enter**.

The **Move** screen appears under **From:**. Scroll to the current location of the cartridge you want to move. Slots that are occupied by a data cartridge are indicated by an asterisk (*).

3. From **To:**, scroll to the location to which you want to move the cartridge. Slots that are occupied by a data cartridge are indicated by an asterisk (*). Press **Enter**.
4. Press **Enter**.

- o If you select an empty location, **No Source Tape** appears on the LCD. Choose a different location.

- o If you select a location that is already occupied, **Destination Full** appears on the LCD. Choose a different location.

Ejecting a Single Cartridge

When you want to remove a single cartridge from the autoloader, you can specify the cartridge you want by bar code or location, or choose the cartridge currently in the tape drive.

To eject a cartridge by bar code:

NOTE: This function is only allowed if the bar code reader is enabled.

1. From the main menu, scroll to **Commands**, and then press **Enter**.
2. From the **Commands** submenu, scroll to **Eject**, and then press **Enter**.
3. From the **Eject** submenu, scroll to **Tape → Mailslot**, and then press **Enter**.
4. Scroll to **By Barcode**.
A bar code label appears.
5. Scroll to the label that corresponds to the cartridge you want to eject. Press **Enter**.

To eject a cartridge by location:

1. From the main menu, scroll to **Commands**, and then press **Enter**.
2. From the **Commands** submenu, scroll to **Eject**, and then press **Enter**.
3. From the **Eject** submenu, scroll to **Tape → Mailslot**, and then press **Enter**.
4. Scroll to **By Location**.

Slots that are occupied by a data cartridge are indicated by an asterisk (*). A slot assigned for and occupied by a cleaning cartridge will be indicated by an @ sign (@). An empty slot assigned to a cleaning cartridge will be indicated by an exclamation point (!). Scroll to the slot containing the cartridge you want to eject.

5. Press **Enter**.

The cartridge you want is ejected from the media door (mailslot).

To eject a cartridge from the tape drive:

1. From the main menu, scroll to **Commands**, and then press **Enter**.
2. From the **Commands** submenu, scroll to **Eject**, and then press **Enter**.
3. From the **Eject** submenu, scroll to **Tape → Mailslot**, and then press **Enter**.
4. Scroll to **From Drive**, and then press **Enter**.

The cartridge you want is ejected from the media door (mailslot).

Using Magazines and Magazine Blanks

Inward Side of a Magazine

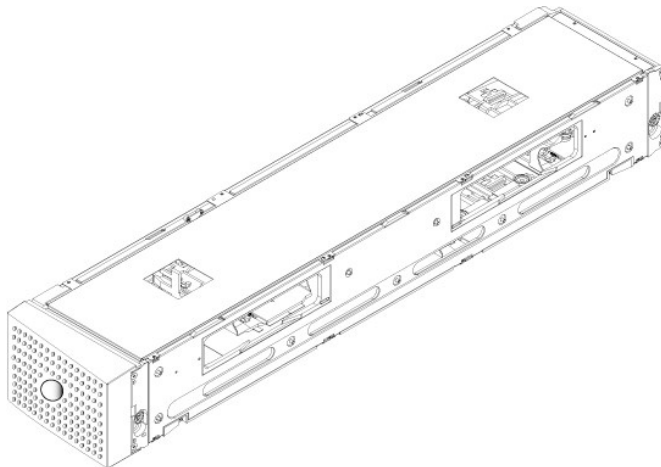

Outward Side of a Magazine

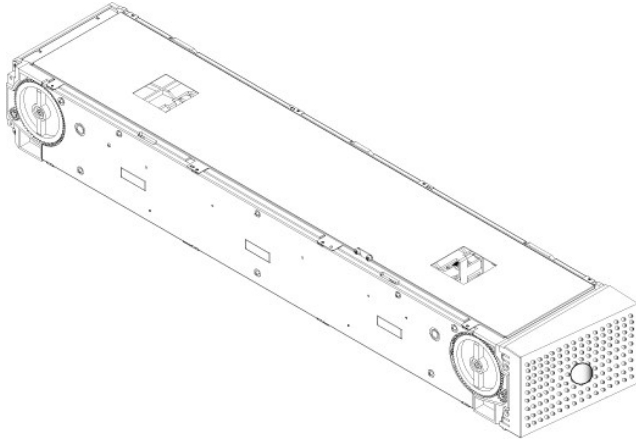

The autoloader will not run unless both magazine bays are properly occupied with either a magazine or magazine blank. One way that you can close the openings is to use two magazines. If you use only one magazine, then you must fill the other magazine opening with a magazine blank for the unit to become operational.

NOTE: Magazines are not interchangeable between drive types. Order the appropriate part numbers when replacing these items.

Ejecting a Magazine

When you want to remove several cartridges at once, eject the magazine(s) first.

To eject a magazine:

1. From the main menu, scroll to **Commands**, and then press **Enter**.
2. From the **Commands** submenu, scroll to **Eject**, and then press **Enter**.
3. On the **Eject** submenu, scroll to **Right Magazine** or **Left Magazine**, and then press **Enter**.

You will hear a distinctive popping sound as the appropriate magazine is ejected from the autoloader. *Left magazine has been ejected* or *Right magazine has been ejected* appears on the LCD.

NOTICE: To prevent damage to the autoloader or the magazine, use both hands when removing the magazine from the autoloader, supporting the entire length of the magazine.

4. Grasp the magazine by the handle with one hand and slide it out, supporting it underneath with the other hand.

NOTE: Once you eject a magazine, you must fully remove it or fully reinstall it before powering off the autoloader. Before returning a magazine to the autoloader, manually turn one of the white thumb wheels located on each end of the magazine. If they move freely, the cartridges are properly seated. If the wheels do not turn freely, check the cartridges and remove and replace as needed.

When issuing a Load/Unload command from software to the autoloader, the system automatically ejects the right magazine. To remove the left magazine using the Load/Unload command, you must:

1. Remove the right magazine.
2. Replace the right magazine with a magazine blank.
3. Issue the Load/Unload command again. The system will then eject the left magazine.
4. If you want to have a magazine in the right bay, replace the magazine blank in the right bay with a cartridge magazine.

Installing a Magazine

To install a magazine into the autoloader, use the following procedure.

1. Grasp the magazine by the handle with one hand and support it underneath with the other hand.
2. Slide the magazine into the magazine bay until it clicks.

Make sure that you position the magazine correctly. It should slide into the magazine bay smoothly. If you meet resistance, verify the orientation of the magazine.

The magazine is correctly installed when you feel it click into place and the front of the magazine is flush with the front panel. *Left Mag Inserted* or *Right Mag Inserted* appears on the LCD. The autoloader automatically proceeds to run an inventory.

NOTICE: Be careful not to turn the knob on the side of the magazine while the magazine is partially inserted into the autoloader. Doing so may cause damage to the magazine or the autoloader.

Manually Operating the Magazine

There are two white thumbwheels, located on each end of the magazine. You can move the slots within the magazine by turning these two white thumbwheels and aligning a slot with one of the two openings. Do not rotate the magazine by inserting your hand and pushing the cartridge carrier. You can use the openings in the magazine to load and unload cartridges from the eight slots within each magazine.

 **NOTICE:** It is recommended that you fully remove the magazine to load and unload cartridges. If the magazine is not fully removed, do not rotate the magazine.

To load cartridges into a fully ejected magazine:

1. To load cartridges into the magazine, center a slot within one of the openings located on the side of the magazine.
2. Properly orient the cartridge; tape upright and bar code label facing outward.

 **NOTE:** There is a keying feature in each slot that only allows you to fully insert the cartridge one way. Make sure there are no labels adhering to the cartridge at any point other than the designated label area.

3. Fully insert the cartridge into the slot.

When pushing the cartridge into the slot, you will feel a small resistance (detent) until the cartridge is properly latched into the slot. All forward progress stops when the cartridge is fully inserted.

You can remove a cartridge in the same manner as you insert it. Use the white thumbwheels to center the desired slot(s) in the openings on the side of the magazine. Do not rotate the magazine by inserting your hand and pushing the cartridge carriers. Using your thumb and index finger, pull out the cartridge. You will feel a small resistance, but continue to pull the cartridge until it comes free.

To identify a slot:

Each slot has an identification number that is exposed when the slots are in the upper section of the magazine. With the magazine removed from the autoloader, you can see the identification mark on the top side of the magazine through one of two windows on the upper surface of the magazine. Each magazine carrier is labeled 1/9, 2/10, 3/11, and so on. Lower numbers 1 - 8 reference slots in the left magazine, higher numbers 9 - 16 reference slots on the right magazine if the optional right magazine is installed.

Running an Inventory

The autoloader automatically runs an inventory whenever you power it back on or insert a magazine. An inventory checks each magazine slot, the drive, the picker, and the media door (mailslot) to determine if a cartridge is present. If so, it also reads the bar code label, if available. If you need to run an inventory in addition to this, you can do so manually.

 **NOTE:** No bar code labels can be read if there is a tape in the picker.

To perform an inventory manually:

1. From the main menu, scroll to **Commands**, and then press **Enter**.
2. From the **Commands** submenu, scroll to **Inventory**, and then press **Enter**. The autoloader scans the bar codes of all the cartridges present.

Viewing Status Information

From the scrolling menu on the LCD, you can view the autoloader status, firmware version, element status, tape drive status, tape drive version, and Ethernet information.

Viewing PowerVault 124T Autoloader Status

The autoloader status provides information about: whether a magazine is installed or not, SCSI connection status, Ethernet connection status, and whether the bar code reader is enabled or not.

To view the autoloader status:

1. From the main menu, scroll to **Status**, and then press **Enter**.
2. From the **Status** submenu, scroll to **Autoloader**, and then press **Enter**.
3. From the **Autoloader** submenu, scroll to **Status**, and then press **Enter**. A list of messages similar to the following appears:

SCSI ID	
A digit 0 through 7 (default 6).	The assigned SCSI ID for the autoloader.
Magazines	
L=*	Asterisk indicates the left magazine is present.
R=*	Asterisk indicates the right magazine is present.
BC Reader	
Yes	Bar code reader enabled
No	Bar code reader disabled

Viewing Firmware Version

To view the current firmware version, use the following procedure:

1. From the main menu, scroll to **Status**, and then press **Enter**.
2. From the **Status** submenu, scroll to **Autoloader**, and then press **Enter**.
3. From the **Autoloader** submenu, scroll to **Version**, and then press **Enter**.

A list of messages appears on the LCD. The firmware version is listed as **Firmware: vx.xx** where x.xx is the current installed version of the firmware.

Firmware The number indicates the firmware version.

EDC The number indicates the Error Correction Code that was generated when the firmware was installed. The autoloader uses this number to verify that the firmware and the memory holding the firmware are good.

HW Rev The number indicates the hardware version.

ME Rev The number indicates the mechanical version.

Viewing Element Status

The element status reports the status of the magazine slots. The status indicates whether a slot contains a cartridge or not, and which slot is allocated as the cleaning cartridge's slot. To view an element's status:

1. From the main menu, scroll to **Status**, and then press **Enter**.
2. From the **Status** submenu, scroll to **Autoloader**, and then press **Enter**.
3. From the **Autoloader** submenu, scroll to **Element Status**, and then press **Enter**.
4. Scroll to view **Drive**, **Mailslot**, and **Picker** status. Scroll and press **Enter** when prompted to view **Magazine** status.

You can scroll through each of the slots. Slots that are occupied by a data cartridge are indicated by an asterisk (*). If a slot assigned to a cleaning cartridge is occupied, it is indicated by an at sign (@). If a slot assigned to a cleaning cartridge is empty, it is indicated with an exclamation point (!).

5. Scroll to the slot containing the cartridge for which you want to see the label, or the cartridge you want to move, and then press **Enter**.

The **Element Status** screen appears, displaying the bar code label for that cartridge.

Viewing Tape Drive Status

To view the tape drive status, use the following procedure.

1. From the main menu, scroll to **Status**, and then press **Enter**.
2. From the **Status** submenu, scroll to **Drive**, and then press **Enter**.
3. From the **Drive** submenu, scroll to **Status**, and then press **Enter**.

A list of messages appears. These messages may include:

SCSI ID Indicates the drive's SCSI ID number.

Compression Indicates whether the tape drive compression is enabled or disabled.

Drive Tape Indicates whether a tape is present in the drive or not.

 **NOTE:**The LTO-2 tape drive can compress data which may allow it to write more data to the same amount of tape. Compression also increases the performance of the data transfers from or to the SCSI bus. The data compression is drive dependent and cannot be set from the front panel or the Remote Management Unit. Your backup application package may also have information on compression.

The front panel display will indicate whether data compression is **Enabled** or **Disabled**. Not all data is compressible and performance is heavily dependent on the type of data being backed up.

Viewing Tape Drive Version

To view the tape drive version, use the following procedure.

1. From the main menu, scroll to **Status**, and then press **Enter**.
2. From the **Status** submenu, scroll to **Drive**, and then press **Enter**.
3. From the **Drive** submenu, scroll to **Version**, and then press **Enter**.

A list of messages appears. These messages may include:

Product Type	Indicates the type of drive installed.
Version	Indicates the firmware version of the drive.

Viewing Ethernet Information

To view the Ethernet information, use the following procedure.

1. From the main menu, scroll to **Status**, and then press **Enter**.
2. From the **Status** submenu, scroll to **Ethernet**, and then press **Enter**.

A list of messages appears. These messages may include:

MAC address	Indicates the unique network identifier associated with the autoloader.
IP address	Indicates the static IP address or currently assigned dynamic IP address. The text <code>⌘⌘⌘</code> displays in this case.
Network	Indicates whether the autoloader is connected to the network or not and at what speed.

[Back to Contents Page](#)

[Back to Contents Page](#)

Remote Management Unit: Dell™ PowerVault™ 124T LTO-2 Autoloader User's Guide

- [Remote Management Unit Overview](#)
 - [Configuration Page](#)
 - [Firmware Page](#)
 - [Error Log and Diagnostics Page](#)
 - [Library Operations Page](#)
-

Remote Management Unit Overview

Your Dell PowerVault 124T LTO-2 autoloader includes an Ethernet interface that allows remote administration. The interface, called the Remote Management Unit (RMU), includes a Web server that provides a Hypertext Markup Language (HTML)-based graphic user interface (GUI) for ease of use.

The RMU performs many of the same functions as the front panel interface. These functions include moving tapes, system operations options, networking options, security options, running diagnostic tests, and performing system updates.

 **NOTE:** Only use the **Diagnostics** commands when the autoloader is known to be idle and unavailable to host backup/restore applications. If a **Diagnostic** command is issued during a drive or autoloader operation, the unit will respond that it is busy. However, if a **Diagnostic** command is issued and then a backup or restore job runs, that job may fail.

 **NOTE:** To log out of the system, you must close your browser.

Default Username and Password

The default username for the Remote Management Unit is **admin**. The default password is **password**.

The username and password are case sensitive and should be entered in all lower case letters. The default username and password are valid if no usernames have been configured.

Opening the Remote Management Unit

The Remote Management Unit has an HTML interface, which means you use a browser to open it. The following Web browsers are supported:

- | For Microsoft® Windows® — Microsoft Internet Explorer 5.5 or later
- | For Microsoft Windows Server® 2003 — Microsoft Internet Explorer 6.0 or later (with latest security patches)
- | For Redhat® 2.1 — Mozilla™ 1.4.2
- | Firefox™ 1.0

If security is enabled, you need an operator password to access the **Library Operations** page, and you need an administrator password to access the **Configuration**, **Error Logs and Diagnostics**, and **Firmware** pages.

When using the RMU with Microsoft Internet Explorer, be sure to enable the **Allow META REFRESH** option. On version 6.0 of Internet Explorer, this feature is controlled through the **Tools>Internet Options** menu selection, under the **Security** tab.

Use of all Remote Management Unit web pages features requires Java Script to be enabled in the user's web browser.

To open the Remote Management Unit:

1. From your computer, open your Web browser.
2. In the browser's address field, enter the IP address for your autoloader (see "[Viewing Ethernet Information](#)").

The **Home** page appears in your browser window.

Viewing Status Information

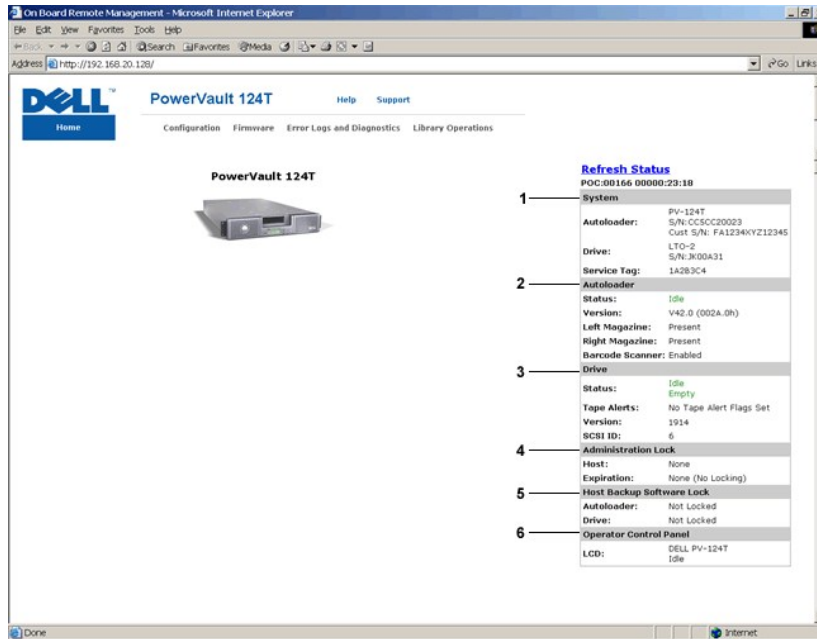

Remote Management Unit (RMU) Web Interface Status Pane

1. **System Status** - provides model and serial number (S/N) of both the autoloader and the drive. This section also contains the Dell Service Tag number. You will need this number if you call for technical support.
2. **Autoloader** - provides status specific to the automation device. Refer to [Front Panel Administration](#) for information regarding magazine configuration. Refer to [Installation Overview](#) for information regarding enabling or disabling the Barcode Scanner.
3. **Drive** - provides status information specific to the drive. Refer to [Installation Overview](#) for information on how to change the SCSI ID. Refer to [TapeAlert Logs](#) for information regarding drive Tape Alert flags.
4. **Administration Lock** - provides status regarding RMU security settings. Refer to [Client Overlap Control](#) for information on how to configure the Administration Lock.
5. **Host Backup Software Lock** - provides status regarding Independent Software Vendor (ISV) autoloader and drive lock settings. These settings must typically be changed from within the host backup software application. Refer to your Backup Software Help or User Guide for steps on how to change autoloader and drive lock settings.
6. **Operator Control Panel** - provides an "OCP mirror," showing text currently displayed on the operator control panel.

Status information appears on the right-hand side of the **Home** page and every page of the Remote Management Unit except for the **Firmware** page. The status information is updated automatically every 10 seconds. Changes to the status appear in the status window update, but may take approximately 10 seconds to refresh. You can also click **Refresh Status** to get an immediate update of the system.

The menu headings also appear at the top of every page. To access the functionality under the menu heading, click the specific menu heading. The first time that you connect, the Remote Management Unit prompts you for your username and password, then displays the opening page for that menu. Depending on your screen resolution settings, you may have to scroll to see all status information.

Time Display

The time displayed is either regular time or power-on time. Regular time is Month/Date/Year time, such as Nov/21/2004 19:28. Power-on time is Power On Cycles (POC)/Power On Hours (POH), such as POC:00121, POH:00002:07:45.

- 1 POC (5-digit number) is the number of times the system has booted since it was manufactured.
- 1 POH is the number of hours, minutes, and seconds that the system has been on since the current boot occurred.

Feedback on Pages

If there is feedback from the system when you submit a request, the feedback appears beneath the **submit** button. In some cases, you may have to scroll to see the feedback information.

Configuration Page

The **Configuration** page includes a submenu on the left-hand side of the page. You can set the **System Operations**, **Networking**, and **Security** options from this page.

System Operations Options

The options listed under **System Operations** include **SCSI ID**, **Compression**, **Barcode Reader**, **Cleaning Tape**, **Magazines**, and **System Time**.

SCSI ID

You can change the drive's SCSI ID from the Remote Management Unit. To change the SCSI ID:

1. From any page, click the **Configuration** heading. The **Configuration** screen displays.
2. Under **System Operations**, select **SCSI ID**.
3. Click the drop-down box to select a number to assign for the new SCSI ID.
4. Click **submit**.

 **NOTE:** You must perform an autoloader reset or use the front panel to power cycle your machine before the new SCSI ID takes effect.

Compression

For the Dell PowerVault 124T LTO-2 autoloader, data compression is drive-dependent. The front panel and the Remote Management Unit will display whether or not compression is enabled.

Compressing the data means that the drive can write more data to the same amount of tape. Compression also increases the performance of the data transfers from or to the SCSI bus.

 **NOTE:** Compression cannot be changed from the front panel or the Remote Management Unit of the autoloader.

To view the compression setting:

From any page, click the **Configuration** heading. The **Configuration** screen displays. Under the **Compression** heading, the current compression setting is displayed as **Compression Enabled** or **Compression Disabled**.

Bar Code Reader

The bar code reader can be enabled or disabled. Disabling the bar code reader prevents the reader from attempting to read label information. If non-bar code labels or no labels are being used, disabling the bar code reader will reduce initialization time at startup or system reset.

Either a power cycle (through the front panel button) or an autoloader reset (through the Autoloader Reset command found on the Error Logs and Diagnostics page) is required for the setting change to take effect.

SCSI Barcode Length sets the maximum number of barcode characters that will be returned in the SCSI Read Element Data. The display of barcode information on the Web interface and Operator Control Panel (OCP) are unaffected by this setting.

Setting the SCSI Barcode Length to 0 disables truncation of the barcode and the full barcode will be returned in the SCSI Read Element Data.

This setting is particularly useful if you have a pool of media previously catalogued by another device that has a limitation on the number of barcode characters that can be read (typically 6 or 9). Adjusting the PV124T setting to match the previous hardware prevents the user from having to re-catalog all barcode labeled media previously used in the other device.

The autoloader does not need to be reset when changing the Barcode Length.

To change the Barcode Reader settings:

1. From any page, click the **Configuration** heading. The **Configuration** Screen displays.
2. Under the **Barcode Reader** section, select the desired **Enable/Disable** option and **Barcode Length** setting and click **Submit**.
3. If the **Enable/Disable** option is changed, the message This will require a power cycle and host backup software configuration change will be displayed.
4. Select **OK**. The front panel and Web interface will display **Please Power Cycle**.
5. Either a power cycle (through the front panel button) or an autoloader reset (through the Autoloader Reset command found on the Error Logs and Diagnostics page of the Web interface) is required for the change to take effect.

Cleaning Tape

To enable or disable the **Auto Clean** function, you must also designate a full slot for the cleaning tape cartridge. If a slot has not been designated, the box displays **None**. To designate the cleaning tape slot:

1. Load a cleaning tape into an empty slot using the **Library Operations** page.
2. Enable or disable **Auto Clean** by selecting the check box. If autoclean is enabled, the cleaning cartridge will automatically be moved from the assigned cleaning slot to the drive if the drive indicates cleaning is required.

 **NOTE:** If **Auto Clean** is disabled, the cleaning tape will automatically be ejected through the media door (mailslot). Cleaning is handled by the backup package you have installed instead.

To set **Auto Clean**:

1. From any page, click the **Configuration** heading. The **Configuration** screen displays.
2. Scroll to **Cleaning Tape**.

If a check mark appears in the box next to **Auto Clean**, the option is enabled. To disable **Auto Clean**, click the box to remove the check mark. If no check mark appears in the box next to **Auto Clean**, the option is disabled. To enable **Auto Clean**, click the box to enter a check mark.

3. In the **Cleaning Tape Location** field, select the appropriate slot location where you installed the cleaning tape. If **Auto Clean** is disabled, cleaning is

handled by the backup package you have installed instead.

4. Click **submit**.

Setting the Magazines

This setting is used to report the number of storage elements and the element address to the SCSI host. This setting must match the physical configuration in order for correct information to be reported. This setting only affects the information reported to the SCSI host. This setting does not affect the access to magazine slots from the front panel or the Remote Management Unit. Those interfaces are based on the physical configuration.

 **NOTE:** The default setting of "Left" must be reconfigured if the optional right magazine is installed. Host backup software may also require reconfiguration if the loader was originally installed with only the default left magazine enabled.

When configured for **Both** magazines, the autoloader always reports 16 storage elements to the SCSI host. This allows the removal and reinstallation of magazines without affecting what is reported to the host. When configured for **Left** or **Right**, the autoloader will always report 8 storage elements to the SCSI host.

The element addresses vary depending on which magazine is configured. If **Left** or **Right** is selected, and both magazines are physically installed, the front panel and the Remote Management Unit allow the user access to the other magazine, but the SCSI host will not have access.

To set the **Magazines** option:

1. From any page, click the **Configuration** heading. The **Configuration** screen displays.
2. Scroll to **Magazines**. The **Magazines** options display.

A radio button appears after the currently enabled mode.

3. Do one of the following:

- o To leave the **Magazines** mode unchanged, press **Esc**.
- o To change the **Magazines** configuration, scroll to the setting you want for the autoloader, selecting the appropriate check box, and then click **submit**. These settings include **Both**, **Right**, and **Left**.

The message *This will require a power cycle and host backup software configuration change. Enter To Continue* is displayed.

- o To continue with the change, press **submit**. The message *Please power cycle the tape autoloader and reconfigure the host backup software app.* displays.

Setting the System Time

The system time is displayed by the Remote Management Unit and it is used internally for logging events and errors (see "[Setting the Time](#)").

The autoloader must be reset after each power up. The time can be reset automatically if a time server is configured (see "[Setting Network Options](#)"). Otherwise, the time must be set manually from the front panel or through the Remote Management Unit. The time zone setting is not lost when powered off.

 **NOTE:** Whether the autoloader is connected to a time server or not, if you want to include time changes for daylight savings time, you must change the time zone manually.

To set the system time:

1. Using the first drop-down list next to **Time Zone**, select the number of hours difference between your local time and Greenwich Mean Time (GMT).

 **NOTE:** For example, if you live in Colorado, the time difference is -6 hours in the summer and -7 hours in the winter.

2. Below the **Time Zone** field, select the current **Month** from the drop-down list.
3. In the **Day** field, type the current day of the month.
4. In the **Year** field, type the current year.
5. In the **Hour** text box, type the current hour in 24-hour format.
6. In the **Minute** text box, type the current minute.
7. Click **submit** to save the information.

Setting Network Options

When you originally installed the autoloader, you set the Ethernet configurations through the front LCD panel. However, you can modify them through the Remote Management Unit. The options include **Current Network Parameters**, **Set IP**, and **Set Network Configuration**. To change the Ethernet configurations:

To view the **Current Network Parameters**:

1. From any page, click the **Configuration** heading. The **Configuration** screen displays.
2. From the **Configuration** menu, click **Networking**.

The **Current Network Parameters** area displays the current IP address, MAC address, and the speed setting for the Ethernet connection.

In the **Set IP** section, if a check mark appears in the box next to **DHCP**, the dynamic IP address option is enabled. This means that with every reset of the

system, the IP address may change depending on the network administrator's settings.

To **Set IP** address:

1. Clear the check box to remove the check mark from the **DHCP** field, if applicable.
2. In the IP address fields, type the static IP address using the <Tab> key to move from box to box.
3. If no check mark appears in the box next to **DHCP**, the static IP address option is enabled. To change a static IP address, type in the new address in the IP address fields using the <Tab> key to move from box to box.
4. To change the IP address from a static address to a dynamic address, click the box next to **DHCP**.

To **Set Network Configuration**:

1. To change the values of the subnet mask, gateway, Simple Network Management Protocol (SNMP) server, or the time server, type in the new address, using the <Tab> key to move from box to box.
2. Click **submit**.

Setting Front Panel Security Options

When you enable the security option, users must enter a password to access the autoloader's front panel functionality. A password allows either administrator-level access or operator-level access (see "[Setting Security](#)"); Up to two Admin and two Operator passwords may be set.

To set security:

1. From any page, click the **Configuration** heading. The **Configuration** screen displays.
2. On the left-hand side of the screen, click **Security**. The **System Security** section of the screen displays.
3. To enable front panel security, select the check box next to **Front Panel Security Enabled**.

If the check box is blank, the security option for the front LCD panel is not enabled.

4. Click **submit**.

To reset the front panel password:

1. From any page, click the **Configuration** heading. The **Configuration** screen displays.
2. On the left-hand side of the screen, click **Security**.
3. Select the check box next to **Reset Front Panel Password**. A check mark appears.
4. Click **submit**.

To set **User Administration**:

1. From any page, click the **Configuration** heading. The **Configuration** screen displays.
2. On the left-hand side of the screen, click **Security**.
3. From the drop-down list next to **Select User Type**, select **Operator 1**, **Operator 2**, **Administrator 1** or **Administrator 2**.
4. In the **Username** field, enter a user name.
5. In the **Password** field, enter the new password.
6. In the **Verify Password** field, re-enter the same new password.
7. Click **submit**.

 **NOTE:** To view the list of currently defined users, click **submit** with **Select User Type** chosen.

To set the **Client Authorization Control**:

1. From any page, click the **Configuration** heading. The **Configuration** screen displays.
2. On the left-hand side of the screen, click **Security**.

Scroll to **Client Authorization Control**. In this section is a list of the IP addresses that are authorized to perform with the Remote Management Unit for this specific unit. There are two sets of IP address boxes. You can individually enable/disable and configure each set.

- o If enabled, each set can be used to specify either a range of IP addresses or a pair of specific IP addresses that are allowed to administer this unit. A set can also be used to specify a single IP address if the desired IP address is entered into both the "a" and "b" portions of the set. When a set is used to specify a range of IP addresses, the "b" portion of each address set must be greater than or equal to the "a" portion of that address set.
- o If neither set is enabled, any IP client can administer the unit. If a single set is enabled, only clients that pass the test specified by that set are allowed administrator access. If both sets are enabled, any client that passes either of the two filter tests can administer the unit.

The Web server always allows any client to view the status information of the unit, regardless of the authorized client list or the overlap control policy.

3. Use the drop-down box to select **Enable** or **Disabled**.
4. Type the IP addresses in the appropriate boxes.
5. Click **submit** to save.

 **NOTE:** By entering an improper range of IP addresses, a user can possibly lock out all IP clients from administering the autoloader. If this occurs, the user can restore the default values by running **Restore Default** from the front panel **Configuration** menu.

Client Overlap Control is a management policy on controlling how the Web server handles overlapping control requests from multiple clients on the authorized client list. The options include **No Locking**, **Full Locking**, and **Time-Based Locking**.

- 1 **No Locking** allows multiple clients to have unrestricted access to control the system as long as they are on the authorized client list.
- 1 **Full Locking** permits only one authorized client to issue control requests at a time. This client must release the lock by clicking the **Home/Logout** option in the upper frame of the page to permit other authorized clients to have control access.
- 1 **Time-Based Locking** is similar to **Full Locking** in that only one authorized client can have control access at once, but the lock is automatically released after the specified number of seconds of inactivity have elapsed.

After selecting the appropriate policy by clicking the check box, click **submit** to save the changes.

1. From any page, click the **Configurations** heading. The **Configurations** screen displays.
2. On the left-hand side of the screen, click **Security**.
3. Select a security option from the **Client Overlap Control** options:
 - o **No locking** allows multiple users to access the system and issue requests.
 - o **Full Locking** allows only one user to access the system and issue requests.
 - o **Time-based Locking** allows only one user to access the system and issue requests with the lock expiring after a designated amount of inactivity (in seconds).
 - o **Home/Logout** is used to release a full or time-based lock and permit another user to access the system.

 **NOTE:** Locking is only available to users on the authorized client list.

4. Click **submit**.
-

Firmware Page

 **NOTE:** The preferred method of autoloader update is through the RMU (Remote Management User web interface). The preferred method for drive update is across the host SCSI interface using the Dell firmware update utility (DFU) supplied with the firmware update package. Refer to the README file provided with the firmware update package.

You can browse to find system updates and then upload the updates. To get system updates:

1. From any page, click the **Firmware** heading. The **Firmware Update** screen displays.
2. Click **Browse** to navigate to the host system for the update file. The file should end in an **.img** extension.

 **NOTE:** It is recommended that all firmware updated be performed with image files located on the local system hard drive as opposed to a removable media or network share drive.

3. Click **Upload**.
4. Click **OK** in response to the confirmation box. The autoloader automatically uploads the new code and processes it to the system.

 **NOTE:** A Microsoft issue may keep a user from updating drive or loader firmware over the RMU interface. This can occur under Windows Server® 2003 with Service Pack 1 (SP1), or if a user has installed Microsoft Security Update MS05-019. This problem displays as a **Communication Error** message on the front panel with the warning light set. The RMU will continue to report the autoloader status as **Initialization**.

For information and a workaround to this problem, go to [Microsoft Technical Support Article 898060](#). If this problem occurs, the autoloader should be restarted to avoid further communication errors.

5. Power cycle the loader, then the server after the firmware update is complete.

 **NOTE:** After the firmware update is complete, the unit will report new revision levels to the host on startup. You may have to reconfigure your host backup software to recognize the updated unit.

Error Logs and Diagnostics Page

From the **Error Log and Diagnostics** page, you can run various tests on the autoloader. You can also view error and history logs, test progress, identify the physical unit in a rack, or reset the system.

Viewing Error or History Logs:

1. From any page, click the **Diagnostics** heading. The **Diagnostics** screen will be displayed.
2. Under **View Error and History Logs**, click **View Logs**. You can also save the logs to a file by clicking **Save Logs**. If you save the logs to a file, you must select a destination folder within 60 seconds.

 **NOTE:** Saved logs taken at point of failure are valuable for assessing problems. Service personnel may request these logs.

Running Diagnostic Tests

A minimum of two cartridges are required to run the diagnostic tests. The diagnostic tests available on the autoloader include:

- 1 Loader – Picker Test
 - 1 Loader – Magazine Test
 - 1 Loader – Inventory Test
 - 1 Loader – Random Moves
1. From any page, click the **Error Log and Diagnostics** heading. The **Error Log and Diagnostics** screen will be displayed.
 2. In the **Diagnostics** section, select the diagnostic test that you want to run from the **Test** drop-down menu.
 3. Specify a loop count, if desired. Valid numbers are from 1 to 99.
 4. Click **submit**.
 5. While the test is running, you can view the status of the test. From **View Diagnostic Test Progress**, click **View Status**.
A separate screen indicates which test is running and the current status of the diagnostic test.
 6. To view diagnostic progress click **View Status** again.

Identification

You can use the **Identification** feature of the autoloader by requesting the LCD backlight to flash for a specified number of seconds. This can be helpful in identifying the location of the autoloader in an equipment room.

1. From any page, click the **Error Log and Diagnostics** heading. The **Error Log and Diagnostics** screen displays.
2. Under **Identification**, enter the number of seconds in the **Time (secs)** field.
3. Click **Identify**. The LCD backlight flashes on the autoloader for the specified number of seconds.

Performing an Autoloader Reset

You will use autoloader reset when making SCSI ID changes and magazine changes. An autoloader reset will take at least three minutes if there is a tape in the drive, or approximately 30 seconds otherwise. To perform an autoloader reset:

1. From any page, click the **Error Log and Diagnostics** heading. The **Error Log and Diagnostics** screen displays.
2. Under the **Autoloader Reset** section, click **Autoloader Reset**.

Library Operations Page

You can move tapes, run a system inventory, reset the picker to its home position, or perform sequential operations from the **Library Operations** page. When you click **Library Operations**, the page displays.

Moving Tapes

From a remote location, you can request that a tape be moved from one position to another. To move a tape:

1. From any page, click the **Library Operations** heading. The **Library Operations** screen displays.
2. From the **Moving Tapes** section of the page, click the drop-down menu under **From:** and select the current location of the tape that you want to move.
 **NOTE:** You can also click the slot on the graphic of the autoloader magazine to select and move a cartridge.
3. From the drop-down menu under **To:**, select the location to which you want to move the tape, and then click **submit**.

Inventory

The autoloader automatically runs an inventory whenever you power it on or insert a magazine. If you need to run an inventory in addition to this, you can use the Remote Management Unit to do it remotely. To run an inventory:

1. From any page, click the **Library Operations** heading. The **Library Operations** screen displays.

2. From the **Library Operations** page, click **Inventory**. The autoloader starts an inventory immediately.

Set to Home

If the autoloader is not able to successfully execute a **Moving Tapes** or an **Inventory** command, try executing a **Set to Home** command, and then retry the move or inventory command again.

The **Set to Home** command resets the autoloader as a means to help the autoloader recover from an unexpected internal condition. To **Set to Home**:

1. From any page, click the **Library Operations** heading. The **Library Operations** screen displays.
 2. From the **Library Operations** page, click **Set to Home**. This executes a reset command to the autoloader.
-

[Back to Contents Page](#)

Technical Specifications: Dell™ PowerVault™ 124T LTO-2 Autoloader User's Guide

- [Physical Specifications](#)
- [Autoloader Performance Specifications](#)
- [Autoloader Environmental Specifications](#)
- [Autoloader Power Specifications](#)
- [Autoloader Vibration Specifications](#)
- [Autoloader Shock Specifications](#)
- [Tape Drive Specifications](#)

Physical Specifications

Characteristic	Product Alone
Height	8.9 cm (3.5 in)
Width	45 cm (17.7 in)
Length	75.46 cm (29.71 in)
Package Weight (without media)	22.7 kg (50 lb)
Footprint	0.32 square meters (3.4 square feet)

Autoloader Performance Specifications

Characteristic	Specification
Maximum data transfer rate	Native: 93.6 GB/hr Compressed: 187.2 GB/hr (assuming 2:1 compression ratio)
Drive type	1 Quantum LTO-2 half-height drive
Number of slots	16 (8 per magazine)
MCBF	400,000 cycles
Interface	Ultra2 SCSI
Initialize element status	90 seconds (typical)
Typical cycle time	< 40 seconds. One cycle consists of moving a cartridge from the tape drive to a magazine slot, selecting another magazine slot, and then moving the cartridge back to the tape drive. It does not include the time that the tape drive takes to unload or load/calibrate.
Average load time (after placing cartridge in drive)	LTO Ultrium 2 = 12 seconds (to BOT for previously written tape) LTO Ultrium 2 = 40 seconds (to BOT with unformatted tape)
Average unload time (from BOT)	LTO Ultrium 2 = 19 seconds (from BOT)

Autoloader Environmental Specifications

Characteristic	Specification
Temperature Range (Dry Bulb)	
Operating	+10° to +35°C
Nonoperating	-40° to +65°C
Temperature Variation	
Operating	10°C per hour
Nonoperating	20°C per hour
Humidity	
Operating	20% to 80% noncondensing
Nonoperating	10% to 90% noncondensing
Gradient	10% per hour without condensation
Wet Bulb	
Operating	26°C maximum
Nonoperating	29°C maximum
Altitude	
Operating	-153 to 3048 m
Nonoperating	-153 to 12192 m
Vibration (5-500 Hz)	
Maximum acceleration to operating	0.25g RMS (random)
Frequency range	500 Hz

Autoloader Power Specifications

Characteristic	Specification
Line voltage	60 Hz system: 90 – 265 VAC 50 Hz system: 90 – 265 VAC
Line frequency	47 – 63 Hz
AC Input current	60 Hz system: 4.0 A (RMS) for 115 VAC 50 Hz system: 2.0 A (RMS) for 230 VAC
Power consumption	60 Hz = 75 W; 50 Hz = 80 W

Autoloader Vibration Specifications

Characteristic	Specification
Operating	
Swept Sine Vibration	5 – 500 Hz, 0.25 G, 0.254 mm (0.01 inch) to smooth crossover, 1 8ve/min, (X, Y, Z) axes
Random Vibration	0.25 Grms, 5 – 500 Hz (X, Y, Z) axes
Nonoperating	
Swept Sine Vibration	5 – 500 Hz, 0.75 G, 0.51 mm (0.02 inch) to smooth crossover, 1 8ve/min, (X, Y, Z) axes
Random Vibration	1.06 Grms, 5 – 500 Hz (X, Y, Z) axes

Autoloader Shock Specifications

Characteristic	Specification
Operating	3 G, 5 ms half-sine, 3 pulses (+/-) per axis, X, Y, Z
Nonoperating	20 G, 8 ms half-sine, 3 shocks (+/-) per axis, X, Y, Z

Tape Drive Specifications

LTO-2 Drive Specifications

Description	Quantum LTO-2
Read/write transfer rate: maximum sustained (LTO Ultrium 2 media)	Noncompressed mode: 93.6 gb/hr Compressed (2:1 typical): 187.2 GB/hr
Burst transfer rate	160 MB/s
Average access time	68 seconds (from BOT)
Loading time to BOT (for previously written tape)	75 seconds (maximum)
Unloading time from BOT	30 seconds (maximum)
MCBF	> 400,000 hours at 100% duty cycle
Interface type	Ultra2 SCSI

Media Capacity

Media type	Capacity
LTO Ultrium 2 storage capacity	6400 GB (compressed) with 16 cartridges

Media Specifications

Characteristic	LTO Ultrium 2
LTO Ultrium 2 formatted capacity	200 GB (noncompressed) 400 GB (2:1 typical compression)
Basic description	Advanced metal particle
Tape length	609 m (1998 ft)
Cartridge dimensions	10.2 x 10.54 x 2.15 cm (4 x 4.15 x .85 in)
Read compatibility	LTO Ultrium 1, LTO Ultrium 2
Shelf life	> 30 years with < 10% loss in demagnetization @ 20°C 40% RH (noncondensing)
Cartridge life	1,000,000 passes (any point on the tape passing the recording head in either direction)
LTO Universal Cleaning cartridge life	15 uses

[Back to Contents Page](#)

Troubleshooting: Dell™ PowerVault™ 124T LTO-2 Autoloader User's Guide

- [Before Contacting Customer Support](#)
- [Operator Control Panel Error Display](#)
- [Checking For Errors](#)
- [Autoloader Logs](#)
- [TapeAlert Logs](#)
- [Returning the Autoloader for Service](#)

Before Contacting Customer Support

Errors that you may experience with your autoloader can range from simple connection problems to more complex hardware failure. Before you return your autoloader, you may be able to fix the problem yourself by following some basic troubleshooting procedures.

Other than drive cleaning, there is no recommended routine maintenance of the Dell PowerVault 124T autoloader.

The operator control panel located at the front of the autoloader provides some troubleshooting capabilities, but is limited. The Remote Management Unit provides more detailed information about the present state of the autoloader and past performance, and is more helpful for troubleshooting errors.

⚠ NOTICE: If you find that you must power cycle the autoloader, do not turn the power back on for at least 10 seconds after powering down. This allows time for the power supply to completely discharge and ensure a complete system reset. If time is not allowed for the discharge, the system may fail to boot properly and will display a blank LCD screen. Power cycle again, waiting at least 10 seconds, to clear the problem.

The following table describes the probable cause and suggested action for problems that you may encounter.

Table 1: Basic Troubleshooting

Problem	Probable Cause	Suggested Action
The front panel does not display information.	The connection to the LCD has failed.	1 Use the Remote Management Unit to troubleshoot error.
Error messages appear on the front panel LCD display.	An error has occurred.	1 Refer to Front Panel Error Display .
The autoloader is operating slowly.	The autoloader, system hardware, or host backup software is incorrectly configured.	1 Go to support.dell.com for configuration requirements.
The autoloader does not turn on.	The power cable is defective or the power source is malfunctioning. The power switch at the back of the autoloader is not turned on.	1 Check all outlets and power cables for proper connection. 1 Check the power switch at the back of the autoloader. 1 Contact support.dell.com .
The front panel does not display information, but light indicators above the front panel are turned on.	A momentary power interruption allowed the autoloader to power off, then back on prior to the power supply being fully discharged.	1 On the front panel, press and hold the power switch for 15 seconds, then turn the rear power switch off. Wait 60 seconds and turn the rear power switch back on. 1 Contact support.dell.com .
The autoloader does not communicate with the host system through the SCSI bus.	A problem within the SCSI cabling path is preventing communication.	1 Verify that the SCSI cables are connected to the rear of the autoloader and that the correct LVD host controller card is installed. 1 Verify that the SCSI cables are not damaged or crimped and the total SCSI cable length is not exceeding the maximum required length. 1 Verify that a LVD SCSI terminator is attached to both the first and last SCSI device on the SCSI bus. 1 Verify that the autoloader SCSI ID is set to a unique SCSI ID that is not used by any other SCSI device on the same SCSI bus. 1 Verify that the host bus adapter is supported for use with the Dell PowerVault 124T on support.dell.com . 1 Issue an Autoloader Reset either by using the Remote Management Unit Diagnostic page or by turning off power from the front panel. 1 Contact support.dell.com .
The tape drive responds on the	A system configuration problem is	1 If the SCSI ID is unique, check SCSI cable and terminator connections.

SCSI bus to the host, but the autoloader does not respond.	preventing communication.	<ul style="list-style-type: none"> 1 Verify that the host application and the device drivers are installed with the most current patches to support the autoloader. 1 Verify that LUN scanning is enabled on the host bus adapter. 1 Contact support.dell.com.
The autoloader does not communicate with the host system through the Ethernet.	A problem with either the Ethernet cabling or network configuration is preventing communication.	<ul style="list-style-type: none"> 1 Verify that the Ethernet cable is connected to the correct hub. 1 Verify the Ethernet configuration settings through the front panel LCD. If the DHCP server is available, Ethernet status should indicate DHCP, otherwise, you must set a unique static IP address and a sub-net mask. The static IP address of the autoloader must be on the same sub-net as the host. 1 If connected directly to the host system, a cross-over cable must be used. 1 Power off the autoloader by turning off the system from the front panel LCD, wait at least 10 seconds, and turn it back on. 1 Contact support.dell.com.
The application software reports a failure locating a piece of media or fails to move a piece of media as requested.	The current host backup software or autoloader inventory has been lost.	<ul style="list-style-type: none"> 1 Use the Remote Management Unit tool and verify that the media is in the expected location internal to the autoloader. 1 Using the Remote Management Unit diagnostic tool, execute the Loader Inventory Test test. 1 Using the Remote Management Unit diagnostic tool, execute the Random Moves test. Note: a minimum of two pieces of media are required for this test. 1 Issue an Autoloader Reset either by using the Remote Management Unit Diagnostic page Autoloader Reset or by turning the power off from the front panel. 1 Retry inventory within the software application. 1 Contact support.dell.com.
The application software reports an error while reading or writing a piece of media.	The current media is defective, or the internal tape drive needs to be cleaned.	<ul style="list-style-type: none"> 1 Try a different piece of media. 1 Use a cleaning cartridge to clean the internal tape drive. 1 Issue an Autoloader Reset either by using the Remote Management Unit Diagnostic page Autoloader Reset, or cycle the power from the front panel. 1 Retry the job within the software application. 1 Contact support.dell.com.
Other failures occur.		<ul style="list-style-type: none"> 1 Refer to Front Panel Error Display for error-specific instruction. 1 Issue an Autoloader Reset either by using the Remote Management Unit Diagnostic page Autoloader Reset, or by turning the power off from the front panel LCD. 1 Contact support.dell.com.

Operator Control Panel Error Display

The Operator Control Panel (OCP) is used for operator input, and to display status and error information output. Errors generated by the autoloader hardware result in error codes unique to the Dell PowerVault 124T. These errors codes are displayed on the OCP along with a brief description of the error. Further information and recommended actions for Dell PowerVault 124T error codes can be found in [Table 2](#).

Errors generated by the internal tape drive are presented in terms of industry standard TapeAlerts. TapeAlerts are also displayed on the OCP along with a brief description of the error. Further information and recommended actions for tape drive TapeAlerts can be found in [Table 3](#).

Checking for Errors

Errors are problems that occur while operating the autoloader. They prevent the autoloader from completing a specific action. When an error occurs, two things can happen:

- 1 An error message appears on the Operator Control Panel (OCP) or in the Remote Management Unit (RMU) screen.

- 1 No error message appears, but the autoloader fails to complete the action.

When either of these things occur, the system generates a log of the error. You can use these error logs to determine the type of error, when it occurred, and what parts of the autoloader it affects. Different types of error logs are generated for the autoloader and for the internal tape drive.

- 1 The [Autoloader Logs](#) provide information for errors related to the autoloader, or data cartridge movement within the autoloader.
- 1 The [TapeAlert Logs](#) provide information for errors reported by the tape drive inside the autoloader.

Autoloader Logs

You can retrieve autoloader error log information through one of three methods:

- 1 Operator Control Panel (OCP)
- 1 Remote Management Unit (RMU) display to screen
- 1 Detailed logs saved to text file through the RMU for call center diagnosis

Further information and recommended actions for Dell PowerVault 124T error codes can be found in [Table 2](#).

Autoloader Logs through OCP

To view Hard Error log information from the front panel:

1. From the front panel LCD, scroll to **Diagnostics**, and then press **Enter**. The **Diagnostics** submenu appears.
2. From the **Diagnostics** submenu, scroll to **Error Logs**, and then press **Enter**. The **Error Log** submenu appears.
3. From the **Error Logs** submenu, scroll to **Hard**, and then press **Enter**. The log information is displayed.
4. You may scroll up and down through the hard log entries. The most recent entry will be associated with the highest event number shown.

Autoloader Logs through RMU

To view hard error log information, or save all logs from the Remote Management Unit:

1. From within the RMU, click the **Diagnostics** heading. The **Diagnostics** screen displays.
2. Click **View Logs** to display the hard error log. The most recent entry will be associated with the highest event number shown.
3. Detailed log information files are particularly useful when calling for support. If you want to save logs to a local text file, click **Save Logs**.

Table 2: Autoloader Error Detail

Error Type	Description	Recommended Action
Autoloader Operating System Failure Types		
01	Resource Deleted	Errors 01-25 indicate that an unexpected event has occurred within the autoloader internal operating system. The autoloader internal operating system is called ThreadX, and some error messages may be preceded by a 'TX' notation. For any of these events: 1 Power cycle the autoloader. 1 Run the Random Moves test from either the Remote Management Unit (RMU) or the Operator Control Panel (OCP). Note: The Random Moves test requires a minimum of two cartridges present within the autoloader. 1 Check support.dell.com for PowerVault 124T firmware updates. 1 If all previous steps fail, contact support.dell.com .
02	Pool Error	
03	Pointer Error	
04	Wait Error	
05	Size Error	
06	Group Error	
07	No Event Timeout	
08	Option Error	
09	Queue Error	
0A	Queue Empty	
0B	Queue Full	
0C	Semaphore Error	
0D	Semaphore Timeout	
0E	Thread Error	
0F	Priority Error	
10	Start Error	
11	Delete Error	
12	Resume Error	
13	Caller Error	
14	Suspend Error	

15	Timer Error	
16	Tick Error	
17	Activate Error	
18	Threshold Error	
19	Suspend Lifted	
1A	Block Pool Error	
1B	Queue Function Failed	
1C	Semaphore Function Failed	
1D	Timer Function Failed	
1F	Thread Function Failed	
20	Command Started	
21	System Failure	
22	System Busy	
23	System Timeout	
24	Software Error	
25	Hardware Error	
Message Error Types		
26	Message Sender (Task) ID Error	<ul style="list-style-type: none"> 1 Verify the host backup application and device driver are at the latest supported revision at support.dell.com. 1 Check host adapter and SCSI cables and terminator.
27	Message Type Bad	<ul style="list-style-type: none"> 1 Power cycle the autoloader and retry the operation.
28	Message Parameter Bad	<ul style="list-style-type: none"> 1 If all previous steps fail, contact support.dell.com.
Stack/Global Data Corruption Error Types		
29	Invalid Element	<ul style="list-style-type: none"> 1 Verify the host backup application and device driver are at the latest supported revision at support.dell.com.
2A	Invalid Element Status	<ul style="list-style-type: none"> 1 Power cycle the autoloader.
2B	Element Table Bad	
2C	Global Data Bad	<ul style="list-style-type: none"> 1 Run the Random Moves test from either the Remote Management Unit (RMU) or the Operator Control Panel (OCP).
2D	Stack Data Bad	Note: The Random Moves test requires a minimum of two cartridges present within the autoloader.
2E	Task Stack Low	
2F	Task Stack Overflow	<ul style="list-style-type: none"> 1 If all previous steps fail, contact support.dell.com.
System Shutdown/Disruption Error Types		
30	POST Failure	<ul style="list-style-type: none"> 1 Verify that the magazines/magazine blank are fully seated. 1 Power cycle the autoloader. 1 If all previous steps fail, contact support.dell.com.
31	Watchdog Timer	<ul style="list-style-type: none"> 1 Power cycle the autoloader.
32	Power Event	<ul style="list-style-type: none"> 1 Run the Random Moves test from either the Remote Management Unit (RMU) or the Operator Control Panel (OCP).
33	Power Down Failure	Note: The Random Moves test requires a minimum of two cartridges present within the autoloader.
34	System Overload	<ul style="list-style-type: none"> 1 Check support.dell.com for PowerVault 124T firmware updates.
35	System Performance	
36	Asynchronous Stop	<ul style="list-style-type: none"> 1 If all previous steps fail, contact support.dell.com.
System Miscellaneous Error Types		
37	System Cleaning Error	<p>Cleaning slot in use.</p> <ul style="list-style-type: none"> 1 Verify that a valid cleaning cartridge is located in the dedicated cleaning slot indicated within the Remote Management Unit Configuration page settings. 1 Check support.dell.com for PowerVault 124T firmware updates. 1 If all previous steps fail, contact support.dell.com.
38	System Internal I2C HW Error	Contact support.dell.com .
39	ALD (Autoloader Diagnostic) Limits Error	<p>This error may occur as a result of a failed diagnostic test.</p> <ul style="list-style-type: none"> 1 If the Magazine Test or Inventory Test failed, remove and inspect the magazines one at a time. Turn the white thumbwheels on each magazine and insure that the carriers move freely at least one full rotation in each direction. Re-insert each magazine after inspection.

		<ul style="list-style-type: none"> 1 If the Picker Test failed, verify there is no obstruction within the picker assembly and repeat the test. 1 If the Random Moves test failed, see steps above for necessary actions. 1 Power cycle the autoloader and re-run the failed test. Contact support.dell.com if failure recurs.
Tape Drive Error Types		
3A	Drive Reset Error	Check the TapeAlert log for more specific drive error information. Refer to Table 3 for recommended actions.
3B	Drive HW Error	
3C	Drive Cleaning Required	<ul style="list-style-type: none"> 1 Perform cleaning by loading a valid cleaning cartridge into the drive. If a slot is available to be dedicated for a cleaning cartridge, this operation can be enabled to run automatically within the Remote Management Unit Configuration page. 1 Check the TapeAlert log for more specific drive error information. Refer to Table 3 for recommended actions. 1 If the drive continues to request cleaning, contact support.dell.com.
3D	General Drive Error	<ul style="list-style-type: none"> 1 Check the TapeAlert log for more specific drive error information. Refer to Table 3 for recommended actions. 1 If the drive is logging Read/Write errors, repeat the operation with new media. 1 If the drive fails with two different pieces of media, contact support.dell.com.
3E	Drive Load Error	<ul style="list-style-type: none"> 1 Perform cleaning by loading a valid cleaning cartridge into the drive. If a slot is available to be dedicated for a cleaning cartridge, this operation can be enabled to run automatically within the Remote Management Unit Configuration page.
3F	Drive Unload Error	<ul style="list-style-type: none"> 1 Try to load a different piece of media. 1 If the operation fails with two different pieces of media, contact support.dell.com.
Drive/Media Error Types		
40	Media Threading Error	<ul style="list-style-type: none"> 1 Check the TapeAlert log for more specific drive error information. Refer to Table 3 for recommended actions. 1 Verify that a valid cartridge type is in use. 1 Repeat operation with a new piece of media. 1 If the operation fails with two different pieces of media, contact support.dell.com.
41	Media Unthreading Error	
42	Media (MAM) Info Error	
43	Invalid Media Type	
44	Expired Cleaning Media	
45	Unknown Media Error	
46	Drive/Media Error	
Miscellaneous Error Types		
47	EEROM Chksum Error	Contact support.dell.com .
48	Fan Sense Motion Error	<ul style="list-style-type: none"> 1 Verify that the main fan is moving freely when the unit is on. 1 If the previous step fails, contact support.dell.com
49	Offline	Diagnostics controlling system. No action required.
4A	Host Lock Prevents Eject	<p>Host backup software has issued PREVENT/ALLOW MEDIUM REMOVAL command, often called a "lock" by the host backup software.</p> <ul style="list-style-type: none"> 1 Issue an Unlock command through the host backup software, or power cycle the autoloader using the Operator Control Panel power button to clear the lock setting.
4B	Open Front	<p>All motor movement, including picker and magazine rotation, has been disabled for safety reasons.</p> <ul style="list-style-type: none"> 1 Verify the magazine or magazine blank is completely inserted on both the left and right sides of the autoloader. 1 Replace magazine or magazine blank (try a second one if possible). 1 If the Random Moves test failed, see steps above for necessary actions. 1 If all previous steps fail, contact support.dell.com.
4C	Over Temp	<ul style="list-style-type: none"> 1 Verify the temperature of the autoloader inlet air is within specification. 1 Clear debris from all openings of the autoloader, both in front and back. 1 Verify that the fan is working. 1 If all previous steps fail, contact support.dell.com.
TCP/IP Stack and Task Error Types		
50	IP Stack Panic	1 Verify that the autoloader is connected to the correct network.

51	IP Stack Memory Allocation Error	1 Verify that the network is properly configured (i.e. no loop-back condition exists).
52	IP Stack Can't Free Memory	1 Verify that the autoloader operates correctly when properly configured and attached directly to a host system using a cross-over cable.
53	Stack DTrap Occurred	1 If all previous steps fail, contact support.dell.com .
Loader Task Error Types		
60	Drive Init Failed	1 Check support.dell.com for PowerVault 124T firmware updates.
61	Drive Login Error	
62	Drive Logout/Unexpected Error	1 Check the TapeAlert log for more specific drive error information. Refer to Table 3 for recommended actions.
63	Drive Command Failed	1 Power cycle the autoloader using the front panel power button and retry the operation.
64	Drive Response Timeout	
65	Command Flushed From Queue	1 If all previous steps fail, contact support.dell.com .
66	Drive Manager Not In Correct State	
67	Drive Reporting Not Ready	
68	Autoclean Move Failed	1 Check the Remote Management Unit autoclean Configuration settings. Insure that a valid cleaning cartridge is located at the configured location. 1 Verify that the cleaning cartridge does not have labels or other matter placed anywhere on the cartridge except where labels are expected to be placed. 1 Try a different cleaning cartridge. 1 If the operation fails with two different cleaning cartridges, contact support.dell.com .
69	Drive Unload Retry	1 Check the TapeAlert log for more specific drive error information. Refer to Table 3 for recommended actions.. 1 Verify that the cleaning cartridge does not have labels or other matter placed anywhere on the cartridge except where labels are expected to be placed. 1 Try to load a different piece of media. 1 Power cycle the autoloader using the front panel power button and retry the operation. 1 If all previous steps fail, contact support.dell.com .
6D	Drive Communications Error	1 Check support.dell.com for PowerVault 124T firmware updates.
6E	Drive Communications Error	1 Check the TapeAlert log for more specific drive error information. Refer to Table 3 for recommended actions. 1 Power cycle the autoloader using the front panel power button and retry the operation.
6F	Loader Communication Error	1 If all previous steps fail, contact support.dell.com .
Code Update Error Types		
70	Failed to Send CUP Cmd to Drive / No Response From Drive	1 Verify the firmware images for both the autoloader and drive are the most recent images located at support.dell.com .
71	CUP Send Failed	1 Review the firmware update readme file provided with the firmware images.
72	Drive Update Failed, Media Present	Note: The recommended method for drive firmware update is through the host SCSI interface using the DFU utility provided with the firmware images. The recommended method for loader firmware update is through the Remote Management Unit.
73	Image Size in Header Too Big	
74	Block Erase Failed	1 Verify all SCSI cable and terminator connections between the host and autoloader.
75	Flash Program Failed	
76	Header Corrupt	1 Verify no media in drive during update.
77	Checksum Error	1 Power cycle the autoloader using the front panel power button and retry the operation.
78	Timeout During CUP	
79	Reset During Drive Update	1 If all previous steps fail, contact support.dell.com .
7A	Unexpected Reset From Drive	
7B	Unexpected Message From PSP	
7C	Personality or Version Check Failed	
7D	SCSI Error During Write Buffer Command	
7E	Uncompressed EDC Failure	
7F	Image Processing Ended Early	
SCSI Server Task Error Types		
80	Unexpected Response or Data Received	1 Verify the host backup application and device driver are at the latest supported revision at support.dell.com .

		<ul style="list-style-type: none"> 1 Check host adapter and SCSI cables and terminator. 1 Power cycle the autoloader and retry the operation. 1 If all previous steps fail, contact support.dell.com.
81	Drive Send Failed	
Servo Elevator Hardware Error Types		
92	Elevator Flag Bad	<ul style="list-style-type: none"> 1 Power cycle the autoloader
93	Elevator Sensor Bad	<ul style="list-style-type: none"> 1 Run the Random Moves test from either the Remote Management Unit (RMU) or the Operator Control Panel (OCP). Note: The Random Moves test requires a minimum of two cartridges present within the autoloader. 1 Check support.dell.com for PowerVault 124T firmware updates. 1 If all previous steps fail, contact support.dell.com.
97	Elevator Calibration Lost	
98	Elevator Calibration Jammed	
99	Elevator Lost	
9B	Elevator Position Error	
Picker/Magazine Servo Error Types		
A0	Servo Error	<ul style="list-style-type: none"> 1 Power cycle the autoloader.
A1	Reserved Error Code	<ul style="list-style-type: none"> 1 Run the Random Moves test from either the Remote Management Unit (RMU) or the Operator Control Panel (OCP). 1 Also execute the Recommended Actions for "Open Front" (4B) error type. Note: The Random Moves test requires a minimum of two cartridges present within the autoloader. 1 Check support.dell.com for PowerVault 124T firmware updates. 1 If all previous steps fail, contact support.dell.com.
A2	Servo Timeout Error	
A3	Position Error	
A4	Servo Not Calibrated	
A5	Source Element Empty	
A5	Source Element Empty	<ul style="list-style-type: none"> 1 Verify that the expected source really does not have a cartridge. 1 Power cycle the autoloader. 1 Run the Random Moves test from either the Remote Management Unit (RMU) or the Operator Control Panel (OCP). Note: The Random Moves test requires a minimum of two cartridges present within the autoloader. 1 If the source is a slot within a magazine, check if the spring loaded cartridge present flag moves freely when the cartridge is manually inserted into the magazine. 1 If the error continues, contact support.dell.com.
A6	Magazine Missing	<ul style="list-style-type: none"> 1 Verify the magazine or magazine blank is fully inserted into the autoloader. 1 Remove and re-insert the magazine. 1 Try a second magazine if possible. 1 Power cycle the autoloader. 1 If the error continues, contact support.dell.com.
A7	Mail Slot Full	<ul style="list-style-type: none"> 1 Remove any previously ejected media from the mail slot. 1 Verify that there is no debris or foreign object in the mail slot opening. 1 Verify the mail slot door is fully closed. 1 If the error continues, contact support.dell.com.
A8	Destination Element Full	<ul style="list-style-type: none"> 1 Verify that the expected destination element already has a cartridge. 1 Power cycle the autoloader. 1 Run the Random Moves test from either the Remote Management Unit (RMU) or the Operator Control Panel (OCP). Note: The Random Moves test requires a minimum of two cartridges present within the autoloader. 1 If the destination is a slot within a magazine, check if the spring loaded cartridge present flag moves freely when the cartridge is manually inserted into the magazine 1 If the error continues, contact support.dell.com.
A9	Picker Full	<ul style="list-style-type: none"> 1 Look in the front of the autoloader and confirm the picker is full. 1 Execute a Move command from the Operator Control Panel to move the cartridge from the picker to a

		location.
		<ul style="list-style-type: none"> 1 Power cycle the autoloader through the front panel. 1 Run the Random Moves test from either the Remote Management Unit (RMU) or the Operator Control Panel (OCP).
AA	Picker Cartridge Sensor Error	<p>Note: The Random Moves test requires a minimum of two cartridges present within the autoloader.</p> <ul style="list-style-type: none"> 1 If the source is a slot within a magazine, check if the spring loaded cartridge present flag moves freely when the cartridge is manually inserted into the magazine. 1 If all previous steps fail, contact support.dell.com.
AB	Drive Path Sensor Error	<ul style="list-style-type: none"> 1 Power cycle the autoloader through the front panel. 1 Run the Random Moves test from either the Remote Management Unit (RMU) or the Operator Control Panel (OCP). <p>Note: The Random Moves test requires a minimum of two cartridges present within the autoloader.</p> <ul style="list-style-type: none"> 1 If all previous steps fail, contact support.dell.com.
AC	Mail Slot Door Sensor Error	<ul style="list-style-type: none"> 1 Power cycle the autoloader. 1 Insert a cartridge into the autoloader through the mail slot. Verify the cartridge is sensed and the door closes fully.
AD	Mail Slot Solenoid Error	<ul style="list-style-type: none"> 1 If all previous steps fail, contact support.dell.com.
AE	Servo Initialization Error	<ul style="list-style-type: none"> 1 Remove and inspect the magazines one at a time. Turn the white thumbwheels on each magazine and insure that the carriers move freely at least one full rotation in each direction. Re-insert each magazine after inspection. 1 Check the barcode reader setting through either the Remote Management Unit or the Operator Control Panel. 1 If the barcode reader is enabled, verify that all cartridges have valid barcode labels. If cartridges do not have valid barcode labels, disable the barcode reader. 1 Check support.dell.com for PowerVault 124T firmware updates. 1 Power cycle the autoloader. 1 Run the Random Moves test from either the Remote Management Unit (RMU) or the Operator Control Panel (OCP). <p>Note: The Random Moves test requires a minimum of two cartridges present within the autoloader.</p> <ul style="list-style-type: none"> 1 If all previous steps fail, contact support.dell.com.
AF	Error Log Information Event	<p>Used to analyze start of servo/motor error sequence in the Soft Error Log. Error entries immediately following indicate nature of specific motor/position error.</p> <ul style="list-style-type: none"> 1 No action required.
Servo Picker Hardware Error Types		
B0	Rotation Sensor Bad	<ul style="list-style-type: none"> 1 Power cycle the autoloader. 1 Run the Random Moves test from either the Remote Management Unit (RMU) or the Operator Control Panel (OCP). <p>Note: The Random Moves test requires a minimum of two cartridges present within the autoloader.</p> <ul style="list-style-type: none"> 1 If all previous steps fail, contact support.dell.com.
B1	Rotation Flag Not Found	
B2	Rotation Flag Bad	
B3	Translation Sensor Bad	
B4	Translation Sensor 1 Bad	
B5	Translation Sensor 2 Bad	
B6	Translation Flag Bad	
B7	Rotational Calibration Lost	
B8	Translation Calibration Lost	
B9	Rotation Lost	
BA	Translation Lost	
BB	Rotation Position Lost	
BC	Translation Position Lost	
BD	Picker Dropped Cartridge Error	<ul style="list-style-type: none"> 1 Check for a jammed cartridge in the picker. Remove the cartridge if present. 1 Remove and inspect the magazines one at a time. Turn the white thumbwheels on each magazine and insure that the carriers move freely at least one full rotation in each direction. 1 Fully insert a cartridge into each magazine slot, then remove. Look for difficulty in extracting the cartridge from each slot.
BE	Picker Missed Cartridge Error	<ul style="list-style-type: none"> 1 Re-insert the magazine after inspection.

		<ul style="list-style-type: none"> 1 Power cycle the autoloader.
BF	Picker Jammed Cartridge Error	<ul style="list-style-type: none"> 1 Run the Random Moves test from either the Remote Management Unit (RMU) or the Operator Control Panel (OCP). <p>Note: The Random Moves test requires a minimum of two cartridges present within the autoloader.</p> <ul style="list-style-type: none"> 1 If all previous steps fail, contact support.dell.com.
Servo Motor Error Types		
C0	Motor Error	<ul style="list-style-type: none"> 1 Insure that the autoloader is resting on a solid flat surface, or mounted level in a rack unit.
C1	Motor SW Error	<ul style="list-style-type: none"> 1 Power cycle the autoloader.
C2	Motor HW Error	
C3	Motor Seg Error	<ul style="list-style-type: none"> 1 Run the Random Moves test from either the Remote Management Unit (RMU) or the Operator Control Panel (OCP).
C4	Motor Position Error	<p>Note: The Random Moves test requires a minimum of two cartridges present within the autoloader.</p>
C5	Motor Direction Error	
C6	Motor Runaway Error	<ul style="list-style-type: none"> 1 Check support.dell.com for PowerVault 124T firmware updates.
C7	Motor Corrupt	<ul style="list-style-type: none"> 1 If all previous steps fail, contact support.dell.com.
C8	Motor Acceleration Error	
C9	Motor Sense Noise	
CA	Motor Seek Error	
CB	Motor Skipped Step	
CC	Motor Stalled	
CD	Motor Jammed	
CE	Motor Translation Pin Jammed Error	
CF	Motor Asynchronous Stop	
Magazine Hardware Error Types		
D0	Magazine Eject Failed	<ul style="list-style-type: none"> 1 Insure that the autoloader is resting on a solid flat surface, or mounted level in a rack unit. <ul style="list-style-type: none"> 1 Remove and re-insert the magazine. Verify that the magazine slides freely in and out of the magazine bay.
D1	Magazine Present Sensor Bad	<ul style="list-style-type: none"> 1 Verify that the magazine clicks and locks in place when fully inserted. 1 Power cycle the autoloader and retry the operation. 1 If all previous steps fail, contact support.dell.com.
D2	Magazine Cam Position Sensor Bad	<ul style="list-style-type: none"> 1 Insure that the autoloader is resting on a solid flat surface, or mounted level in a rack unit. 1 Remove and re-insert the magazine. Verify that the magazine slides freely in and out of the magazine bay.
D3	Magazine Sensor 1 Bad	<ul style="list-style-type: none"> 1 Verify that the magazine clicks and locks in place when fully inserted. 1 Power cycle the autoloader and run the Magazine Test from the Operator Control Panel.
D4	Magazine Sensor 2 Bad	<ul style="list-style-type: none"> 1 If all previous steps fail, contact support.dell.com.
D5	Magazine Flag Missing	<p>Magazine errors may occur if the magazine sensor cannot detect cartridge carrier flags during magazine rotation. This may be caused by an issue with a cartridge carrier flag, a sensor problem, a physically jammed magazine, or a sensor alignment issue caused by a mis-inserted magazine.</p>
D6	Magazine Flag Bad	
D7	Slot Zero Not Found	
D8	Multiple Slot Zero Detected	<ul style="list-style-type: none"> 1 Insure that the autoloader is resting on a solid flat surface, or mounted level in a rack unit. 1 Remove and inspect the magazines one at a time. Turn the white thumbwheels on each magazine and insure that the carriers move freely at least one full rotation in each direction.
D9	Magazine Step Tolerance Error	<ul style="list-style-type: none"> 1 Verify that carrier flags are present on all slots and slot 1 has the unique (longer) carrier flag.
DA	Magazine Calibration Lost	<ul style="list-style-type: none"> 1 Insure that the sensors protruding from the picker into the magazine bays are free of debris, and 'float' in and out freely when pushed by hand.
DB	Magazine Lost	
DC	Magazine Position Error	<ul style="list-style-type: none"> 1 Carefully re-insert the magazine straight into the magazine bay. Be careful to avoid twisting or biasing the magazine up or down.
DD	Magazine Slot Type Invalid	<ul style="list-style-type: none"> 1 Power cycle the autoloader.
DE	Magazine Slot (Gross) Position Error	<ul style="list-style-type: none"> 1 Run the Magazine Test from the operator control panel. 1 If all previous steps fail, contact support.dell.com.
DF	Magazine Jammed Error	
System Event Types		
E8	Time Zone Update Event	User updated the time zone setting. No action required.

E9	Time Update Event	The system time was changed. No action required.
Front Panel Error Types		
EA	LCD Busy Error	Possible LCD controller problem, software error, or communication error. 1 Power cycle the autoloader.
EB	LCD Goto Error	1 Run the Random Moves test. 1 If all previous steps fail, contact support.dell.com .
EC	Login/Password Error	Incorrect login from front panel.
ED	Socket Error During SNTP	1 Use correct login/password.
Barcode Error Types		
F0	Bar Code Init Error	1 Remove magazines and inspect cartridges. Verify that valid barcode labels are being used on all cartridges, and re-insert the magazines.
F1	Bar Code Hardware Error	1 If barcode labels are not being used, disable the barcode reader through the Operator Control Panel or Remote Management Unit.
F2	Bar Code Baud Rate Error	1 Run the Random Moves test from either the Remote Management Unit (RMU) or the Operator Control Panel (OCP).
F3	Bar Code Handshake Error	Note: The Random Moves test requires a minimum of two cartridges present within the autoloader.
F4	Bad/Noisy Response From Bar Code Reader	1 If all previous steps fail, contact support.dell.com .
F5	Checksum Failed	Incomplete barcode label or barcode checksum failed. 1 Repeat test with new cartridge or label. 1 If problems recur with the original cartridge or label, replace. 1 If all previous steps fail, contact support.dell.com .
F6	Barcode No Read	Barcode label not present. 1 Apply valid barcode label to cartridge, or disable the barcode reader through the Operator Control Panel or Remote Management Unit.
F7	Barcode Mismatch Error	1 Power cycle the autoloader. 1 Run the Random Moves test from either the Remote Management Unit (RMU) or the Operator Control Panel (OCP). Note: The Random Moves test requires a minimum of two cartridges present within the autoloader. 1 If all previous steps fail, contact support.dell.com .
F8	Barcode Duplicate Label Error	Duplicate barcode.
Diagnostic Error Types		
F9	Diagnostic Test Failure	1 Power cycle the autoloader. 1 Re-run the failing diagnostic test. 1 If all previous steps fail, contact support.dell.com .
FA	Diagnostic Error, Drive Reporting Write Protect	1 Verify that valid, not data protected media is present for test. 1 Run the Random Moves test from either the Remote Management Unit (RMU) or the Operator Control Panel (OCP).
FB	Diagnostic Error, Cleaning Tape Inserted	Note: The Random Moves test requires a minimum of two cartridges present within the autoloader. 1 If all previous steps fail, contact support.dell.com .
FC	Diagnostic Load Tape Prompt	This is a prompt to manually load a cartridge as required for test.
FD	Diagnostic Unknown Tape Format	1 Verify that valid, not data protected media is present for test. 1 Run the Random Moves test from either the Remote Management Unit (RMU) or the Operator Control Panel (OCP). Note: The Random Moves test requires a minimum of two cartridges present within the autoloader. 1 If all previous steps fail, contact support.dell.com .
FE	Diagnostic Invalid Configuration	This is an indication that a minimum of two pieces of media are required for test. 1 Insure at least two cartridges are present in the autoloader and re-run the failed test.

TapeAlert Logs

You can retrieve TapeAlert log information through one of three methods:

- 1 Operator Control Panel (OCP)
- 1 Remote Management Unit (RMU) display to screen
- 1 Detailed logs saved to text file through the RMU for call center diagnosis

Further information and recommended actions for tape drive TapeAlerts can be found in [Table 3](#).

TapeAlert Logs through OCP

To view TapeAlert log information from the front panel:

1. From the front panel LCD, scroll to **Diagnostics**, and then press **Enter**. The **Diagnostics** submenu appears.
2. From the **Diagnostics** submenu, scroll to **TapeAlert Logs**, and then press **Enter**. The TapeAlert log information is displayed.
3. You may scroll up and down through the TapeAlert log entries. The most recent entry will be associated with the highest event number shown.

Within each TapeAlert log entry, you may scroll up and down to display the date and time that an error occurred, the barcode label associated with the tape being used at the time of error (if barcode labels are being used and the barcode reader is enabled), and any TapeAlert flags set during that event.

TapeAlert Interpretation

In order to display any combination of TapeAlerts that may be set for any one event, a binary representation is used. The 16 character hexadecimal TapeAlert representation is broken down into a total of 64 bits (16 x 4 = 64), one for each possible TapeAlert that may be reported. The illustration below demonstrates TapeAlert bit assignment, as well as practical examples. In the first example, the tape drive requested cleaning. In the second example, cleaning was attempted with an invalid cleaning cartridge.

 **NOTE:** The binary representation for every possible TapeAlert is presented in [Table 3](#). Multiple TapeAlerts may be set as shown in the following example:

```
TapeAlert Representation: 0000000000000000 hexadecimal
                        ^
                        |
1st hexadecimal digit = 0000 binary (0's and 1's)

TapeAlert[1], 1st bit set = 1000 binary = 8 hexadecimal
TapeAlert[2], 2nd bit set = 0100 binary = 4 hexadecimal
TapeAlert[3], 3rd bit set = 0010 binary = 2 hexadecimal
TapeAlert[4], 4th bit set = 0001 binary = 1 hexadecimal
:
:

Examples:

1) 0000100000000000    TapeAlert[20] Clean now

2) 0020020000002000    TapeAlert[11] Cleaning media in drive
                        + TapeAlert[23] Invalid cleaning tape
                        + TapeAlert[51] Tape directory invalid at unload
```

TapeAlert Logs through RMU

To view TapeAlert log information from the Remote Management Unit, or save all logs:

1. From within the RMU, click the **Diagnostics** heading. The **Diagnostics** screen displays.
2. Click **TapeAlert Logs** to display the TapeAlert log. The most recent entry will be associated with the highest event number shown.

 **NOTE:** This option is particularly useful for locating suspect media. The screen output will display a history of unit TapeAlerts, current TapeAlerts reported by the drive, and a history of TapeAlerts recorded on each cartridge since being inserted in the autoloader.

3. Detailed log information files are particularly useful when calling for support. If you want to save logs to a local text file, click **Save Logs**.

Table 3: TapeAlert Detail

Tape Alert Message	Typical Application Client Message	Probable Cause Of Error Message	Recommended Action
Drive TAflag[01] Read Warning TapeAlert Log Entry: 8000000000000000	The tape drive is having problems reading data. No data has been lost, but there has been a reduction in the performance of the tape.	The drive is having severe trouble reading. This can be caused by bad media or the drive.	1 Clean the drive 1 Try another piece of media. 1 If no errors are encountered with the alternate piece of media, retry the original media.
Drive TAflag[02] Write Warning TapeAlert Log Entry: 4000000000000000	The tape drive is having problems writing data. No data has been lost, but there has been a reduction in the capacity of the tape.	The drive is having severe trouble writing. This can be caused by bad media or the drive.	1 Clean the drive 1 Try another piece of media. 1 If no errors are encountered with the alternate piece of media, retry the original media.
Drive TAflag[03] Hard Error TapeAlert Log Entry: 2000000000000000	The operation has stopped because an error has occurred while reading or writing data that the drive cannot correct.	The drive had a hard read or write error. This can be caused by bad media or the drive.	1 Clean the drive 1 Try another piece of media. 1 If no errors are encountered with the alternate piece of media, retry the original media.
Drive TAflag[04] Media TapeAlert Log Entry: 1000000000000000	Your data is at risk. Copy any data you require from this tape. Do not use this tape again.	Media can no longer be written/read, or performance is severely degraded.	1 Clean the drive 1 Try another piece of media. 1 If no errors are encountered with the alternate piece of media, retry the original media.
Drive TAflag[05] Read Failure TapeAlert Log Entry: 0800000000000000	The tape is damaged or the drive is faulty.	The drive can no longer read data from the tape.	1 Clean the drive 1 Try another piece of media. 1 If no errors are encountered with the alternate piece of media, retry the original media.
Drive TAflag[06] Write Failure TapeAlert Log Entry: 0400000000000000	The tape is from a faulty batch or the tape drive is faulty.	The drive can no longer write data to the tape.	1 Clean the drive 1 Try another piece of media. 1 If no errors are encountered with the alternate piece of media, retry the original media.
Drive TAflag[07] Media Life TapeAlert Log Entry: 0200000000000000	The tape cartridge has reached the end of its calculated useful life.	The media has exceeded its specified life.	Copy any data you need to another tape. Discard the old tape.
Drive TAflag[08] Not Data Grade TapeAlert Log Entry: 0100000000000000	The cartridge is not data-grade. Any data you write to the tape is at risk.	The drive has not been able to read the MRS stripes	Replace the cartridge with a data-grade tape.
Drive TAflag[09] Write Protect TapeAlert Log Entry: 0080000000000000	You are trying to write to a write protected cartridge.	Write command is attempted to a write protected tape.	Remove the write protection or use another tape.
Drive TAflag[10] No Removal TapeAlert Log Entry: 0040000000000000	You cannot eject the cartridge because the tape drive is in use. Wait until the operation is complete before ejecting the cartridge.	Manual or software unload attempted when prevent media removal is on.	1 Check in the RMU if the Software Lock is set. 1 Perform an unlock using the Backup Application.
Drive TAflag[11] Cleaning Media TapeAlert Log Entry: 0020000000000000	The tape in the drive is a cleaning cartridge.	Cleaning tape loaded into drive.	
Drive TAflag[12] Unsupported Format TapeAlert Log Entry: 0010000000000000	You have attempted to load a cartridge of a type that is not supported by this drive.	Attempted load of unsupported tape format. (e.g., Unformatted Type IV media in a VS160 drive.)	Use tape format correct for the drive type.
Drive TAflag[13] Recoverable Mechanical Cartridge Failure TapeAlert Log Entry: 0008000000000000	The operation has failed because the tape in the drive has experienced a mechanical failure.	Tape snapped/cut or other cartridge mechanical failure in the drive where medium can be de-mounted.	Discard the old tape. Restart the operation with a different tape.
Drive TAflag[14]	The operation has failed because the tape	Tape snapped/cut or other	Discard the old tape. Restart the operation

Unrecoverable Mechanical Cartridge Failure TapeAlert Log Entry: 0004000000000000	in the drive has experienced a mechanical failure.	cartridge mechanical failure in the drive where medium cannot be de-mounted.	with a different tape.
Drive TAflag[15] Memory Chip In Cartridge Failure TapeAlert Log Entry: 0002000000000000	The memory in the tape cartridge has failed, which reduces performance. Do not use the cartridge for further write operations.	Memory chip failed in cartridge.	Replace cartridge.
Drive TAflag[16] Forced Eject TapeAlert Log Entry: 0001000000000000	The operation has failed because the tape cartridge was manually de-mounted while the tape drive was actively writing or reading.	Manual forced eject while drive actively writing or reading.	Retry operation using the same media.
Drive TAflag[17] Read Only Format TapeAlert Log Entry: 0000800000000000	You have loaded a cartridge of a type that is read-only in this drive. The cartridge will appear as write protected.	Media loaded that is read-only format.	Check write protect tab on cartridge.
Drive TAflag[18] Tape Directory Corrupted On Load TapeAlert Log Entry: 0000400000000000	The tape directory on the tape cartridge has been corrupted. File search performance will be degraded. The tape directory can be rebuilt by reading all the data on the cartridge.	The tape drive powered down with tape loaded, or permanent error prevented the tape directory from being updated.	<ul style="list-style-type: none"> 1 Retry operation with same tape. 1 If error persists, discard tape.
Drive TAflag[19] Nearing Media Life TapeAlert Log Entry: 0000200000000000	The tape cartridge is nearing the end of its calculated Media may have life.	Media may have exceeded its specified number of passes.	<ul style="list-style-type: none"> 1 Use another tape cartridge for your next backup. 1 Store this tape cartridge in a safe place in case you need to restore data from it.
Drive TAflag[20] Clean Now TapeAlert Log Entry: 0000100000000000	The tape drive needs cleaning.	The drive has responded as if it has a head clog or needs cleaning.	<ul style="list-style-type: none"> 1 If the operation has stopped, eject the tape and clean the drive. 1 If the operation has not stopped, wait for it to finish and then clean the drive. Check the tape drive user's manual for device specific cleaning instructions.
Drive TAflag[21] Clean Periodic TapeAlert Log Entry: 0000080000000000	The tape drive is due for routine cleaning.	The drive is ready for a periodic cleaning.	<ul style="list-style-type: none"> 1 Wait for the current operation to finish. 1 Then use a cleaning cartridge. Check the tape drive user's manual for device specific cleaning instructions.
Drive TAflag[22] Expired Cleaning Media TapeAlert Log Entry: 0000040000000000	The last cleaning cartridge used in the tape drive has worn out.	The cleaning tape has expired.	<ul style="list-style-type: none"> 1 Discard the worn out cleaning cartridge. 1 Wait for the current operation to finish. 1 Then use a new cleaning cartridge.
Drive TAflag[23] Invalid Cleaning Tape TapeAlert Log Entry: 0000020000000000	The last cleaning cartridge used in the tape drive was an invalid type.	Invalid cleaning tape type used.	<ul style="list-style-type: none"> 1 Do not use this cleaning cartridge in this drive. 1 Wait for the current operation to finish. 1 Then use a valid cleaning cartridge.
Drive TAflag[24] Retension Requested TapeAlert Log Entry: 0000010000000000	The tape drive has requested a retension operation.	The drive is having severe trouble reading or writing that will be resolved by a retension cycle.	<ul style="list-style-type: none"> 1 Perform a retension operation. 1 Retry operation.
Drive TAflag[25] Dual port Interface Error TapeAlert Log Entry: 0000080000000000	A redundant interface port on the tape drive has failed.	Failure of one interface port in a dual-port configuration (i.e., Fibre Channel).	
Drive TAflag[26] Cooling Fan Failure TapeAlert Log Entry: 0000004000000000	A tape drive cooling fan has failed.	Fan failure inside tape drive mechanism or tape drive enclosure.	
Drive TAflag[27] Power Supply Failure TapeAlert Log Entry: 0000002000000000	A redundant power supply has failed inside the tape drive enclosure.	Redundant PSU failure inside the tape drive enclosure or rack subsystem.	Check the enclosure user's manual for instructions on replacing the failed power supply.

Drive TAflag[28] Power Consumption TapeAlert Log Entry: 0000001000000000	The tape drive power consumption is outside the specified range.	Power consumption of the tape drive is outside specified range.	
Drive TAflag[29] Drive Maintenance TapeAlert Log Entry: 0000008000000000	Preventive maintenance of the tape drive is required.	The drive requires preventative maintenance (not cleaning).	Check the tape drive user's manual for device specific preventive maintenance tasks.
Drive TAflag[30] Hardware A TapeAlert Log Entry: 0000004000000000	The tape drive has a hardware fault.	The drive has a hardware fault that requires reset to recover.	<ul style="list-style-type: none"> 1 Eject the tape. 1 Reset the drive. 1 Restart the operation.
Drive TAflag[31] Hardware B TapeAlert Log Entry: 0000002000000000	The tape drive has a hardware fault.	The drive has a hardware fault that is not read/write related or requires a power cycle to recover.	<ul style="list-style-type: none"> 1 Power cycle the tape drive. 1 Restart the operation.
Drive TAflag[32] Interface TapeAlert Log Entry: 0000001000000000	The tape drive has a problem with the application client interface.	The drive has identified an interface fault.	<ul style="list-style-type: none"> 1 Check the SCSI interface cables, terminator, and all connections. 1 Restart the operation.
Drive TAflag[33] Eject Media TapeAlert Log Entry: 0000000800000000	The operation has failed.	Error recovery action	<ul style="list-style-type: none"> 1 Eject the tape or magazine. 1 Insert the tape or magazine again. 1 Restart the operation.
Drive TAflag[34] Download Fail TapeAlert Log Entry: 0000000400000000	The firmware download has failed because you have tried to use the incorrect firmware for this tape drive.	Firmware download failed.	Obtain the correct firmware and try again.
Drive TAflag[35] Drive Humidity TapeAlert Log Entry: 0000000200000000	Environmental conditions inside the tape drive are outside the specified humidity range.	Drive humidity limits exceeded.	
Drive TAflag[36] Drive Temperature TapeAlert Log Entry: 0000000100000000	Environmental conditions inside the tape drive are outside the specified temperature range.	Cooling problem.	
Drive TAflag[37] Drive Voltage TapeAlert Log Entry: 0000000080000000	The voltage supply to the tape drive is outside the specified range.	Drive voltage limits exceeded.	
Drive TAflag[38] Predictive Failure TapeAlert Log Entry: 0000000040000000	A hardware failure of the tape drive is predicted.	Predictive failure of drive hardware.	
Drive TAflag[39] Diagnostics Required TapeAlert Log Entry: 0000000020000000	The tape drive may have a hardware fault	The drive may have a hardware fault that may be identified by extended diagnostics (i.e., SEND DIAGNOSTIC command).	<ul style="list-style-type: none"> 1 Run extended diagnostics to verify and diagnose the problem. 1 Check the tape drive user's manual for device specific instructions on running extended diagnostic tests.
Drive TAflag[50] Lost Statistics TapeAlert Log Entry: 0000000000040000	Media statistics have been lost at some time in the past.	Drive or library powered on with tape loaded	<ul style="list-style-type: none"> 1 Clean drive. 1 Retry operation.
Drive TAflag[51] Tape Directory Invalid at Unload TapeAlert Log Entry: 0000000000200000	The tape directory on the tape cartridge just unloaded has been corrupted. File search performance will be degraded.	Error preventing the tape directory being updated on unload.	The tape directory can be rebuilt by reading all the data.
Drive TAflag[52] Tape System Area Write Failure TapeAlert Log Entry: 0000000000100000	The tape just unloaded could not write its system area successfully.	Write errors while writing the system area on unload.	<ul style="list-style-type: none"> 1 Copy data to another tape cartridge. 1 Discard the old cartridge.
Drive TAflag[53] Tape System Area Read Failure	The tape system area could not be read successfully at load time.	Read errors while reading the system area on load	Copy data to another tape cartridge.

TapeAlert Log Entry: 0000000000000800			
Drive TAflag[54] No Start Of Data TapeAlert Log Entry: 0000000000000400	The start of data could not be found on the tape.	Tape damaged, bulk erased, or incorrect format.	<ul style="list-style-type: none"> 1 Check that you are using the correct format tape. 1 Discard the tape or return the tape to your supplier.
Drive TAflag[55] Loading Failure TapeAlert Log Entry: 0000000000000200	The operation has failed because the media cannot be loaded and threaded.	The drive is unable to load the media and thread the tape.	Remove the cartridge, inspect it as specified in the product manual, and retry the operation.
Drive TAflag[56] Unrecoverable Unload Failure TapeAlert Log Entry: 0000000000000100	The operation has failed because the medium cannot be unloaded.	The drive is unable to unload the medium.	Remove the cartridge if possible, inspect it as specified in the product manual, and retry the operation.
Drive TAflag[57] Automation Interface Failure TapeAlert Log Entry: 0000000000000080	The tape drive has a problem with the automation interface.	The drive has identified an interface fault.	<ul style="list-style-type: none"> 1 Check the power to the automation system. 1 Check the cables and cable connections.
Drive TAflag[58] Firmware Failure TapeAlert Log Entry: 0000000000000040	The tape drive has reset itself due to a detected firmware fault.	Firmware issue encountered.	
Drive TAflag[59] WORM Medium - Integrity Check Failed TapeAlert Log Entry: 0000000000000020	The tape drive has detected an inconsistency during the WORM medium integrity checks.	WORM cartridge may have been tampered with.	Replace WORM medium.
Drive TAflag[60] WORM Medium - Overwrite Attempted TapeAlert Log Entry: 0000000000000010	An attempt had been made to overwrite user data on WORM medium.	The application software does not recognize the medium as WORM.	<ul style="list-style-type: none"> 1 If a WORM medium was used inadvertently, replace it with a normal data medium. 1 If a WORM medium was used intentionally: <ul style="list-style-type: none"> - check that the software application is compatible with the WORM medium format you are using. - check that the medium is bar-coded correctly for WORM.

Returning the Autoloader for Service

If you need to return the autoloader or a component of the autoloader for service, contact support.dell.com. The following steps will help you to prepare the autoloader for shipment, remove the autoloader from a rack, and package the autoloader.

To prepare the autoloader for shipment

1. Remove all cartridges from the unit.
2. Power off the autoloader through the front panel.
3. Remove the power, Ethernet, and SCSI cables, and any terminators from the autoloader.

 **NOTE:** Do not ship these items if you are returning the autoloader.

To Remove the Autoloader from a Rack

1. Loosen the two thumb screws that secure the loader to the front of the rack.
2. Using two people, or an appropriately rated mechanical lift, remove the autoloader from the rack by sliding the autoloader out and supporting it from the bottom.
3. Place the autoloader into the original packaging box, or the packaging from the replacement unit.

Packing the Autoloader

Gather the original packaging material to pack the autoloader: the shipping box, two foam end caps, accessory package insert (placed at the back of the unit), and the antistatic bag. You will also need packing tape.

1. Place the antistatic bag over the autoloader.
2. Place one of the foam end caps onto each end of the autoloader. Place the second foam insert onto the other side of the autoloader and make sure the pieces fit snugly onto the autoloader.

 **NOTE:** The foam end caps are not identical. Refer to the diagram on the box flaps for proper orientation.

3. Place the autoloader into the shipping box and push the front of the autoloader towards the front end of the box.
4. Insert the accessory package insert at the back of the unit.

 **NOTE:** The accessory package insert is to be placed at the back of the unit, not the front. Refer to the diagram on the box flaps for proper orientation.

5. Place any necessary paperwork on top of the autoloader inside the box.
6. Close and seal the box.
7. Place the shipping label on the box.

[Back to Contents Page](#)